



BALOO'S BUGLE



Volume 21, Number 6

“Make no little plans; they have no magic to stir men's blood and probably themselves will not be realized.
Make big plans; aim high in hope and work.” — Daniel Hudson Burnham (1846-1912)

February 2015 Cub Scout Roundtable

March 2015 Core Value & Pack Meeting Ideas

COMPASSION / BE AWARE AND CARE

Tiger Cub, Wolf, Bear, Webelos, & Arrow of Light Meetings and Activities

CORE VALUES

Cub Scout Roundtable Leaders' Guide

Core Value Highlighted This Month: Compassion

Being kind and considerate, and showing concern for the well-being of others

Why "Be Aware and Care" for Compassion?

A Compassionate Scout imagines himself in the situation of others and feels sympathetic to the distress. As we become aware of the needs of all creatures on Earth, we gain compassion for everything that inhabits our world and the importance of understanding that we are all linked together. This is the reason Scouts are conservation – minded and understand the need to recycle, conserve energy, and follow the principles of Leave No Trace.

Scout Law equivalents to Compassion are

Friendly –

A Scout is a friend to all. He is a brother to other Scouts. He offers his friendship to people of all races and nations, and respects them even if their beliefs and customs are different from his own.

Kind

A Scout knows the strength in being gentle. He treats others as he wants to be treated. Without good reason, he does not harm or kill any living thing.

The Scout Law equivalents are being presented as part of the preparation for One Oath/One Law when all scouts will be using the Scout Oath and Law be they Cub Scouts, Boy Scouts, Venturers or ...

All I want is the same thing you want. To have a nation with a government that is as good and honest and decent and competent and compassionate and as filled with love as are the American people.

Jimmy Carter

to the California State Senate May 1976

TABLE OF CONTENTS

In many of the sections you will find subdivisions for the various topics covered in the den meetings

CORE VALUES	1
TABLE OF CONTENTS	1
Florence Nightingale	2
DEN MEETING TOPICS	4
PACK MEETING THEMES	4
UPCOMING MONTHS	5
Connecting COMPASSION with Outdoor Activities	7
Compassion Character Connection	7
March Crazy Holidays.....	10
THE BUZZ.....	13
Experience Oriented Scouting	13
Get Outdoors with the Camp Scout App	13
BSA SOCIAL NETWORKS.....	13
CUBCAST	14
SCOUTCAST.....	14
Bryans Blog.....	14
Training Topics	18
Cubmaster for Dummies	18
PROGRAM UPDATE	19
Watch this: 'A Brief History of Cub Scouting'	19
Missed the Cub Scout webcasts? Here's how to get up to speed.....	19
ROUNDTABLE UPDATES	20
TRAINING ON THE ADVENTURE PROGRAM	21
Roundtable Note.....	22
The Parable of the Pencil.....	23
The Parable of the Pencil, parts 2 & 3	24
DEN MEETINGS.....	30
TIGERS.....	30
WOLF	32
BEAR	35
WEBELOS DENS.....	37
Communicator Ideas.....	45
Sportsman Ideas	46
Bike Rodeo Events	49
Activities for Kids to Develop Riding Skills, Bike Handling Ability.....	50

Compassion Ideas 51

 Roundtable Prayer 51

 Barnyard Blues (& Golds) Planting Seeds!..... 51

 Gathering Game in honor of National Buzzard Day 51

 No Matter How Small Story 52

 Johnny Appleseed Hidden Picture Challenge 52

 A Matter of Compassion Opening 52

 A Kind, Compassionate Hero Audience Participation 53

 Compassion Through the Ages Advancement Ceremony. 53

 Passion for Compassion Song 53

 Compassion Has No Limits Game 53

 If It's Harder, It's Even More Important Cubmaster's Minute 54

 The Act of Compassion Cubmaster's Minute 54

 Connect with your World Cubmaster's Minute 54

 Compassion and Friends Cubmaster's Minute..... 54

 Connecting COMPASSION with Outdoor Activities 54

 Lighthouse Game 55

 Craft panda magnets, magnets, neckerchief slides 55

 Late Breaking News Game 55

 One-Of-A-Kind Pet Craft..... 55

 Nature Field Trip..... 56

 Our Feathered Friends..... 56

 Butterfly Activity 56

 Kanji..... 56

 Flag Ceremony 56

Be Aware and Care Ideas 57

 Planting Seed of Kindness Opening 57

 Helping Others 58

 Mighty Oaks From Little Acorns 58

 Garden Song..... 58

 Baden-Powell & Good Deeds 59

 Talking Clearly: 59

 Cub Scout Garden 59

 Do More 60

 Holiday Pledge Of Allegiance 60

world with her compassion for the patients, dedication to duty, and contributions to nursing profession.

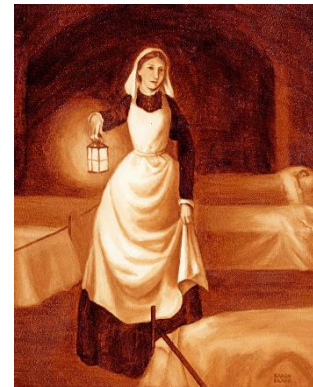

Born to a comfortable family, Florence Nightingale was educated by governesses and then by her father, with her older sister, Parthenope. She was familiar with the Greek and Latin classical languages, and modern languages of French, German, and Italian. She also studied history, grammar, and philosophy. At twenty, she overcame parental objections to receive tutoring in mathematics.

Called to a Mission in Life:

On February 7, 1837, Florence Nightingale heard, by her account, the voice of God telling her that she had a mission in life. It took her some years of searching to identify that mission. This was the first of four occasions where Florence Nightingale said she heard the voice of God.

By 1844, over parental objections, Florence Nightingale chose a different path than the social life and marriage expected of her by her parents -- she chose to work in nursing, which was then not quite a respectable profession for women.

Florence Nightingale went to Kaiserwerth in Prussia to experience a German training program for girls who would serve as nurses. She worked briefly for a Sisters of Mercy hospital near Paris. Her views began to be respected.

Florence Nightingale in the Crimea:

When the Crimean War began, reports came back to England about terrible conditions for wounded and sick soldiers. Florence Nightingale volunteered to go to Turkey, and at the urging of a family friend, then secretary of state at war. Thirty-eight women, including 18 Anglican and Roman Catholic sisters, accompanied Florence Nightingale to the warfront.

From 1854-56, Florence Nightingale headed nursing efforts in English military hospitals in Scutari, Turkey. She established more sanitary conditions and ordered supplies, beginning with clothing and bedding. She gradually won over -- at least enough to get cooperation -- the military doctors. She used significant funds raised by the London Times. About her The Times wrote: "She is a 'ministering angel' without any exaggeration in these hospitals, and as her slender form glides quietly along each corridor, every poor fellow's face softens with gratitude at the sight of her. When all the medical officers have retired for the night and silence and darkness have settled down upon those miles of prostrate sick, she may be observed alone, with a little lamp in her hand, making her solitary rounds."

Florence Nightingale

How could I choose anyone else besides a nurse as an example of Compassion?? Especially after being married to one for over 38 years?? CD

"A nurse is compassion in scrubs." Lexie Saige

Florence Nightingale's lasting contribution has been her role in founding the modern nursing profession. She set an example of **compassion**, commitment to patient care, and diligent and thoughtful hospital administration. Florence Nightingale was a nurse in the British Army and gave up her aristocratic life to take up a job, with what was considered to be a beggars profession. She thought nursing was a form of 'divine calling' during her young years. She was sent to the army hospital during the Crimean War and was appalled by the pathetic conditions of the hospitals. She soon began advocating clean up of the hospitals, as it was the main cause of the soldier's death. Here, she tapped her mathematical and statistical talents to analyze medical data. She became a hero throughout the

Soon, Florence Nightingale focused more on administration than on actual nursing. But she continued to visit the wards, and to send letters back home from injured and ill soldiers. Her rule that she be the only woman in the wards at night earned her the title "The Lady with the Lamp." The mortality rate at the military hospital fell from 60% at her arrival to 2% six months later.

Florence Nightingale applied her education and interest in mathematics to develop statistical analyses of disease and mortality, inventing the use of the pie chart.

Florence Nightingale fought both a not-too-willing military bureaucracy and her own illness with Crimean fever to eventually become general superintendent of the Female Nursing Establishment of the Military Hospitals of the Army (March 16, 1856).

Return to England:

Florence Nightingale was already a heroine in England when she returned, though she actively worked against the adulation of the public. She helped to establish the Royal Commission on the Health of the Army in 1857, and gave evidence to the commission and compiled her own report, published privately in 1858. She also became involved -- from London -- in advising on sanitation in India.

Florence Nightingale was quite ill from 1857 until the end of her life, living in London, mostly as an invalid. She used the privacy provided by the disease to continue her writing choosing when to receive visits from people.

In 1860 she founded the Nightingale School and Home for Nurses in London, England, using funds contributed by the public to honor her work in the Crimea. In 1861, she helped inspire the Liverpool system of district nursing, which later spread widely.

By 1901, Florence Nightingale was completely blind. The King awarded her the Order of Merit in 1907, making Florence Nightingale the first woman to receive that honor.

Florence Nightingale declined the offer of a national funeral and of burial at Westminster Abbey, requesting that her grave be marked simply.

"Nurses dispense comfort, compassion, and caring without even a prescription." *Val Saintsbury*

Other Famous Nurses

As you read above, Nursing was a profession that was taken up by girls and women of the lower class during the 19th century. It was not considered to be a well accepted profession for women and the public perception of nurses was not very high. But, women like Florence Nightingale with their selflessness and desire, to help people in need, changed the outlook of society towards nursing. Nurses became the backbone of the medical profession, without whom the sick and injured would have been lost. During war-time, the duties of nurses made them front-runners in hospitals, who gave emotional support to the injured soldiers away from home. They became the most respected women who not just lent a helping hand, but **compassionately** lent a patient ear to the sick who wanted to share their woes. Famous nurses throughout history helped change the future of medicine with their courage and

intelligence. Here are some famous nurses in history who will always be admired by the medical community for their **compassionate** acts and altruistic dedication.

Famous Nurses in the Civil War - Civil war has seen many heroes emerge from different walks of life, and women were not left far behind with their acts of courage. Many women dedicated their life to help the sick and injured men from war and get them back to their feet

Dorothea Dix - She was a US nursing pioneer who was a strong advocate for the mentally ill patients and even prisoners. She was the driving force behind the first mental asylums to be started in the United States. She was not only an outspoken social activists, but also was the Civil War Superintendent of Union Army of Nurses. Dorothea Dix asked the MA legislature for reforms in 1843 to end the inhumane conditions the mentally ill were kept in.

Mary Ann Bickerdyke - She was known as 'Mother Bickerdyke' who cared for thousands of Union soldiers in 1861. She is known to run army field hospitals all by herself. Mary Ann Bickerdyke was the only woman who could enter Sherman's camps.

Mary Todd Lincoln - Mary Todd Lincoln was not only the first lady of America, but a tireless nurse. She was well-educated woman from Lexington, Kentucky who married Abraham Lincoln. She is remembered for her dedication in tending wounded soldiers during the Civil War.

Clara Barton - One of the most famous women in American history Clarissa Harlowe Barton is known as the 'angel of the battlefield'. During the Civil War, she carried supplies to the battlefield and is known as the founder of Red Cross.

"The door that nobody else will go in at, seems always to swing open widely for me." *Clara Barton*

DEN MEETING TOPICS

When a Den Meeting occurs depends on when you start your year and how often you meet. A Den that starts in August will be doing meetings 1 & 2 then, and 3& 4 in September. A den that meets three times a month will do 1, 2, and 3 in September. *The pace is up to you!!*

MONTH/ CORE VALUE ALTERNATE PACK MTLG THEME	FEBRUARY - RESOURCEFULNESS		MARCH - COMPASSION		APRIL - FAITH	
	LITTER TO GLITTER		AWARE AND CARE		SOARING THE SKIES	
MEETING #	11	12	13	14	15	16
<u>TIGERS</u>	E#47 Recycling E#21 Puppets	E#41 Visit a Transportation Station	E#26 Phone Manners E#27 Emergency E#15 Colors E#12 Card	E#31 Animals E#43 Vet field trip	E#3 Board Game or Puzzle	E#33 Clean up Treasure Hunt E#23 Mik, E#25 Snack
<u>WOLVES</u>	Ach. #12 Choices	E#6 Books E#12a Sketch	E#14 Pets	E#10 American Indians	E4b,e Marbles	E18a Picnic E #19 Fishing
<u>BEARS</u>	Ach. #8 The Past, Ach. #17 Information	Ach. #5 Sharing Your World with Wildlife	Ach. #5 Shining Your World with Wildlife	Ach. #6 Take Care of Your Planet	Ach. #21 Models	Ach. #21 Models
<u>WEBELOS</u>	Engineer	Engineer	Craftsman	Craftsman	Scholar	Showman
<u>ARROW OF LIGHT</u>	Handy Man	Sportsman	Communicator	Sportsman	Sportsman	
<u>RT FOCI</u>	January 2015		February 2015		March 2015	
	Big Rock Ideas - Role of the Unit Commissioner, Effective Advancement, (Create One), Interest Topic - Den Chief Program, Session Topics - Outdoor, Winter Programs and Activities, Meet the Scoutmaster (for Webelos), The Pack Trainer, Pack Pizzazz		Big Rock Ideas - Community Service, Preventing Leader Burnout, (Create One), Interest Topic - One Club, One Law Rollout, Session Topics - Den Ceremonies & Recognitions, Youth Leadership, Summer Camping Opportunities, 100% Boy's Life		Big Rock Ideas - Create a Big Rock on religious Awards, Community Service Interest Topic - Getting Ready for the Adventure Program, Session Topics - Nutrition, Pack Record Keeping, Membership recruiting and Leadership selection.	

PACK MEETING THEMES

Commissioner Dave (with help from Kim)

All 36 Supplemental Pack Meeting plans are posted at: <http://www.scouting.org/scoutsource/CubScouts/Leaders/DenLeaderResources/DenandPackMeetingResourceGuide/PackMeetingPlans.aspx>

Any Pack/Cubmaster can use any theme any month. The year designation is to show you which themes will be featured at Roundtables each year. The 2014 - 2015 RT year kicked off in August with Cooperation and Under the Big Top. Now it is Responsibility and Dollars and Sense.

Here are the remaining themes to be featured for 2014-2015 in the CS RT PG -

Month	Core Value	Supplemental Theme
• March	Compassion	Aware and Care
• April	Faith	Soaring the Skies
• May	Health and Fitness	Backyard Fun
• June	Perseverance	Go for the Gold
	**Obedient	Play Ball
• July	Courage	Under the Sea
	**Loyal	Scout Salute
• August	Honesty	Play Ball
	**Courteous	S'More Cub Scout Fun

**** - These are the Core Values and Themes for the first three months of the new Cub Scout Adventure**

Kim, the chair of the task force, says "I do want to stress that the focus is still the Core Value and the theme is just there as an enhancement. The theme pack meeting plans are specifically crafted to bring out the important points of the Core Value in a fun way."

		2014-2015 CSRT PG	
		* Under the Big Top	
		* Dollars and Sense	
		* Give Goodwill	
		* Stars and Stripes	
		* Yes, I Can	
		* Litter to Glitter	
		* Aware and Care	
		* Soaring the Skies	
		* Backyard Fun	
		* Go for the Gold	
		* Under the Sea	
		* Play Ball	
Supplemental Pack Meeting Themes to Enhance the			
Set A		Set B	
2012-2013 CSRT PG		2013-2014 CSRT PG	
* Hometown Heroes		* Amazing Games	
* Jungle of Fun		* Down on the Farm	
* 50 Great States		* Your Vote Counts	
* Holiday Lights		* Passport to Other Lands	
* Abracadabra		* Lights, Camera, Action	
* Turn Back the Clock		* Invention Convention	
* Planting Seeds of Kindness		* Pet Pals	
* Cub Scouts Give Thanks		* My Family Tree	
* Cub Café		* Destination Parks	
* Head West Young Man		* Over the Horizon	
* Cubs in Shining Armor		* Space - The New Frontier	
* Kids Against Crime		* Heroes of History	
Month	Core Value		
September	Cooperation		
October	Responsibility		
November	Citizenship		
December	Respect		
January	Positive Attitude		
February	Resourcefulness		
March	Compassion		
April	Faith		
May	Health & Fitness		
June	Perseverance		
July	Courage		
August	Honesty		

UPCOMING MONTHS

★ March's Core Value, **Compassion**, will use "Pet Pals."



Month's that have themes that might help you with , **Compassion** and "Aware and Care " are:

Month	Year	Theme
Handicap Awareness		
July	2002	Inside Out and Backwards
March	2004	Walk In My Shoes
Aware and Care		
December	1940	Good Will - Cub Style
December	1941	Giving Good Will
December	1942	Good Will
December	1943	Good Will Month
December	1944	The Other Fellow
December	1945	Follows - Helps - Gives
December	1947	Helps and Gives
December	1948	Goodwill
December	1949	The Other Fellow
December	1950	Helps (for institutions)
December	1951	F-H-G
December	1961	Follows, Helps, and Gives
September	1965	Barn Raising
December	1969	The Cub Scout Gives Good Will
December	1971	Cub Scout Gives Good Will
December	1972	Follows, Helps, Gives
December	1975	Cub Scout Gives Good Will
December	1984	Do a Good Turn
December	1985	Follows, Helps, Gives
December	1986	The Golden Rule
December	1991	Follows, Helps, Gives
December	1992	To Help Other People
December	1995	Do a Good Turn
December	1996	Helping Others
December	1997	The Golden Rule
December	2003	A Cub Scout Gives Good Will

Table continued on next page

Compassion		
March	2011	Compassion
March	2012	Compassion
March	2013	Planting Seeds of Kindness
March	2014	Pet Pals
March	2015	Aware and Care

Core Value Patches are available at www.scoutstuff.org
 For Theme patches go to
<http://www.cubmasterbobkatt.com/Cubmaster-Bob-Katt-Cub-Scout-Monthly-Themes.htm>

★ April's Core Value, Faith, will use "Soaring the Skies"



Why "Soaring the Skies" for Faith?
 When you try something new, innovative, or dangerous. It takes faith to make the attempt – faith that a higher power will guide you and keep you safe. It takes faith when we want to fly into the soaring skies. We need faith in the pilots, co-pilots, the engine and electrical system, the compass, and all the airplane's instruments. More importantly, it is faith that gives you the courage to board the plane, knowing that a higher power will make sure you take off, fly to your destination, and land safely. This month's theme reminds us that faith helps us reach for the sky with our goals and that we should keep faith in all aspects of our lives.

Based on the description above, I have included themes that had material for planes but also these like "Genius Night" that encourage boys to think outside the box and try new things while having Faith that they will work!!! CD

Month's that have themes that might help you with Faith and "Soaring the Skies " are:

Month	Year	Theme
Themes with Planes		
May	1943	Aircraft
April	1946	Air Month
May	1950	Air Fun
June	1954	Air Adventures
June	1955	Wheels Wings and Rudders
April	1961	Air Adventure
July	1961	Harbors, Stations, Airports
May	1989	Wheels, Wings & Rudders
August	1990	Harbors, Stations & Airports
November	1994	Harbors, Stations & Airports
March	2010	Take Flight
Try Something New, Innovative, or Dangerous		
October	1952	Doorway to Adventure
March	1954	Cub Scouts in the Land of OZ
February	1961	Genius Night
November	1964	Cub Scout Genius
September	1966	Cub Scout 49'ers
September	1968	Doorway to Adventure
February	1970	Genius Night
November	1973	Genius Night
May	1977	Genius Night
September	1977	Doorways to Adventure
March	1981	Genius Night
September	1981	Doorway to Adventure
May	1987	Genius Night
June	1988	Genius Night
June	1992	Genius Night
January	1998	Genius Night
October	1998	Imagine That!
March	2005	Invention Convention
February	2014	Invention Convention
January	2015	Yes, I Can
Compassion		
March	2011	Compassion
March	2012	Compassion
March	2013	Planting Seeds of Kindness
March	2014	Pet Pals
March	2015	Aware and Care

Connecting COMPASSION with Outdoor Activities

Wendy, Chief Seattle Council
(Adapted from B.A.L.O.O. Appendix E)

- ★ **HIKES** - Take turns carrying items for each other on a hike. Do an "Inch Hike" to become aware of small animals we may harm if walking quickly.
- ★ **NATURE ACTIVITIES** - Make bird feeders and keep them filled for at least one winter season. Play "The Camera Game" from the *Cub Scout Leader's How to Book*.
- ★ **SERVICE PROJECTS** - Give service to elderly or disabled people, such as helping with trash, filling birdfeeders, planting flowers, sweeping, watering, taking in newspapers, etc.
- ★ **GAMES & SPORTS** - Experience a disability in a game or sport. For instance by being blindfolded or having an arm rendered unusable, teach understanding when others have trouble with a game. Never tease. Show how winning is doing one's best.
- ★ **CEREMONIES** - Hold a ceremony to recognize compassionate behavior - especially compassion to peers.
- ★ **CAMPFIRES** - Give a skit showing compassionate behavior. Don't laugh if someone makes a mistake. Clap and cheer for everyone.
- ★ **DEN TRIPS** - Visit shut-ins and/or elderly people at times other than holidays. Be patient and compassionate when waiting for others who need to rest or are slower.
- ★ **PACK OVERNIGHTER** - Bring someone who needs friends. Share belongings with others who may have forgotten something. Be kind to those who may feel uncomfortable being away overnight.



Compassion Character Connection

Carol at www.cubroundtable.com

Bear Book

Character Connection - Compassion.

Achievement 24, "Be a Leader" (Page 174)

- ✓ **Know** - Tell y as a leader, it is important to shoe kindness and concern for other people. List ways leaders show they care about the thought and feelings of others.
- ✓ **Commit** - Tell why a good leader must consider the ideas, abilities, and feelings of others. Tell why it might

be hard for a leader to protect another person's well-being.

Tell ways you can be kind and compassionate.

- ✓ **Practice** - While you complete the requirements for this achievement, find ways to be kind and considerate of others.

The Resourcefulness Character Connections is not in the Tiger, Wolf or Webelos Handbooks.

World Friendship Fund•

CS Program Helps - 2003-2004, page 6 December and page 10 March

Boy Scouts of America administers the World Friendship Fund to help Scouting associations around the world which are in need of assistance in doing their work. Once a year, BSA asks packs to contribute to this fund. This would be a good time of the year for your pack to demonstrate its goodwill of other Scouters. A free kit or World Friendship Fund materials is available by writing:

World Friendship Fund
International Division, S221
Boy Scouts of America
P. O. Box 152079
Irving, TX 75015-2079

Lighthouse Game

An activity to increase awareness of visual impairments.

The leader is the lighthouse. Half the group will be the ships. They go to one end of the room and put on blindfolds. The other half are rocks and distribute themselves on the floor between the ships and the lighthouse, keeping their hands and feet in to minimize tripping.

The lighthouse says, "Woo, Woo" to guide the ships. The rocks go "Swish, Swish" quietly to warn the ships of their presence.

On "Go," the ships navigate between the rocks to the lighthouse. If they touch a rock, they are sunk and must sit on the floor (and go "swish, Swish" also). When all the ships have made it to the lighthouse (or have been sunk), the rocks and ships switch places.

After playing the game and making contributions to the World Friendship Fund, lead a den discussion:

- What does being *Compassionate* mean?
- What does it mean to have compassion for other people? Can you think of what compassion shows others about you?
- Can you think of a time when someone was kind or compassionate towards you? How did that make you feel? How would you have felt if the person or people were not kind or compassionate?
- What are two ways you can show compassion at school?
- How can you show compassion for someone who is having a difficult time? What can you do to show others that you have compassion? Can you think of a person who would benefit from compassion?

World Conservation Panda

CS Program Helps - 2003-2004, page 6 December and page 10 March

Makes panda magnets, magnets, neckerchief slides. Or pencil toppers. Use white and black pom poms and wiggle eyes. Attach a piece of magnet to the back or a piece of ½ " PVC pipe to make it into a neckerchief slide.

Character Connection: Compassion

The World Conservation pandas represent animals that are endangered in our world. We have an obligation to our future to protect all creatures.

- What do you think will happen to the animals of our world if their environment is destroyed? What does it mean to have compassion?
- Do you feel like you have compassion for animals? How would you feel if someone didn't care about you?
- What might make people feel compassion for animals? What can we do to show compassion for animals?

Differences Awareness Trail

RT Planning Guide 2003-2004 page 47

Set up a variety of stations where boys can experience various physical challenges. Challenges might include stations where boys:

- ✓ Wear eyeglasses smeared with petroleum jelly to simulate impaired vision.
- ✓ Place cotton in the ears or wear ear protectors to simulate impaired hear.
- ✓ Tie magazines around the knees to simulate walking difficulties. If available, have boys attempt to use a walker.
- ✓ Are given a copy of the sign language alphabet. Have someone sign different sayings from a Cub Scout handbook.
- ✓ Are given directions to perform a simple task from someone speaking in a foreign language?
- ✓ Are given a copy of the Braille alphabet. From a Braille board made with dots of hot glue on a piece of cardboard, the boys try to "read" different words and phrases.
- ✓ Have 2 fingers wrapped together to simulate a broken finger, then attempts to tie his shoe.
- ✓ Use a balance board to simulate inner ear problems.
- ✓ Use a pair of crutches or a walker and attempt to negotiate an obstacle course.
- ✓ Use the opposite hand and attempt to write his name.
- ✓ Wear heavy work gloves to stimulate difficulty with gripping objects and try to stack pennies.
- ✓ Use only one arm and try to put on and button up; a jacket or sweater.

Late Breaking News

CS Program Helps - 2004-2005, page 10 January

Have the boys sit in a circle.

The object of the game is for each boy to add three words to a single story as it is passed around the group. The three words should help describe an incredible news story, the funnier the better.

The leader should begin the story slowly by saying something like, "Late last night,"

The second person might add, "...A green monster...";

And so on. If someone gets stuck and can't think of anything to add, keep going and go back to that person later.

Keep the game moving along.

Character Connection: Compassion

How do you decide what gets printed or reported? What choices did you make when you decided what to report?

- ✓ Why is it important to decide what to write about?
- ✓ Think about a time when someone said something dishonest about you. What was your reaction? How did it make you feel?
- ✓ How can you show that you have compassion for other's feelings?

One-Of-A-Kind Pet

CS Program Helps - 2004-2005, page 6May

Materials:

- Craft odds and ends so that each Cub can create a pet that is one of a kind.
- For the body; a stuffed sock, block of wood, box, rock, empty tin can or even a berry basket.
- Additional materials may include construction paper, paper plates, plastic utensils, pipe cleaners, craft sticks, etc.

Directions:

- Cubs (and partners) may finish this project at home.
- Boys will bring their pets the following week so they can show their new pets to the rest of the den and tell their names, high light the kind of body they have, show how many legs they have, show the tail, etc.
- They can describe where the pets came from, what they eat, what they sound like, what they like to do, whether they live on land, in the water, or can fly, etc.

Character Connection: Compassion

- What do you think about the life of the animals at the shelter?
- When you give something to help, is it compassion? What does it mean to have compassion?
- Do you feel you have compassion for the animals at the shelter? How do you think the animals will react when they get these things?
- What else can you do to show compassion for these animals? Are there other animals we can feel compassion for (such as those in the rainforest, or endangered species)?

Cubmaster's Minute: Animal Skills

Cub Scout Program Helps 2004 -2005 page 4 May

With all the wonderful skills dogs can learn, there is one thing they cannot do. Dogs cannot see colors. As a matter of fact, monkeys and apes are the only animals that can see colors.

Do you ever feel like you cannot do something because you are too small, too clumsy, or too young? Well, next time you do, remember the dog and how he can retrieve objects, guide the blind, track lost people – all without being able to distinguish colors. We all have our special talents.

Nature Field Trip

Cub Scout Program Helps 2005- 2006 page 6 April

Lead a discussion related to the field trip:

- When we care about and try to help our fellow creatures, we call that compassion.
- Where do you see or feel compassion? For someone at school or in your family?
- How can you show that you have compassion for someone or something? What could you do to show others you have compassion for them?

Compassion -

2004 Pow Wow Book by Great Salt Lake Council

Having consideration and concern for the well-being of others. Don't isolate or exclude anyone. Everybody has something valuable to offer, and nobody likes being left out. Help your Cubs be aware of the needs of others. Disabled children deal with limitations imposed in their everyday lives.

Game - Fumble Fingers. Divide the den into two teams. Tell players to untie their shoelaces. Then tell them to put one hand behind their back (or tie one hand to belt). On "go", each team tries to tie their shoelaces, with each player using only one hand. First team finished wins. If this is too hard, allow boys to help each other, each using only one hand and working together.

Game - Ships in the Fog. Divide the den into two teams and line them up relay fashion at one end of the room. For each team set up a series of obstacles: chairs, tables, stools, etc., Between them and the other end of the room. Blindfold the first player on each team. On "go" he starts for the other end of the room, trying to avoid the obstacles. His teammates may call out directions: Go right, Turn left, etc.. When he reaches the other end of the room, he takes off the blindfold and runs back to touch off the next Player, who is already blindfolded. Continue until all team members have raced. First team finished wins.

Our Feathered Friends

2005 Pow Wow Book by Great Salt Lake Council

Use Dominos to demonstrate the chain reaction effect of showing compassion.

Line the Dominos up in a row as you mention compassionate deeds. Then knock the last Domino over to illustrate how showing compassion spreads. Add more compassionate deeds as necessary.

Example:

- 1) Build a birdhouse
- 2) Build a birdfeeder
- 3) Build a birdbath
- 4) Do not disturb a bird's nest

Compassion Reflection on Dominos:

- What do think will happen to the birds if their environment is destroyed?
- What does it mean to have compassion?
- Do feel like you have compassion for birds?
- How would you feel if someone didn't care about you?
- What can you do to show compassion for birds?

Butterfly Activity

Cub Scout Program Helps 2006-2007 page 6 May

Compassion - We've created three stages of a butterfly-- caterpillar, cocoon, and butterfly. (Tiger Elective 2)

- Has this helped you understand this animal and the challenges it faces in its life cycle?
- Do you want to be careful when you see a caterpillar? That is . How can you show compassion for other things?
- What can you do to practice compassion in the week ahead?

Create A Caterpillar (Tiger Elective 2)

Materials:

- Section of a paper egg carton (three cups long so you can get four per dozen eggs),
- Craft paints, paintbrushes,
- Chenille stems, small pompoms,
- Wiggle eyes,
- Craft glue,
- Pencil

Directions:

- Give each Tiger Cub a section of egg carton (the caterpillar).
- Allow him to decorate it.
- Give each boy two 1½-in. pieces of chenille stem.
- Glue a small pom-pom to one end of each of the chenille stems.
- Have adult partners use the pencil to poke a small hole in each side of the caterpillar head for the chenille stem antennas.
- Glue the wiggle eyes to the front of the caterpillar.

Cocoon Model

Materials:

- Small twig,
- Lots of yarn or string (depending on thickness—at least 10 ft. Per boy),
- Small piece of cardboard (1 by 3 in.),
- Scissors, tape

Directions:

- Curve the corners of cardboard so that it is roughly oval shaped.
- Use a small piece of tape to secure one end of the yarn to the cardboard.
- Have the Tiger Cub wrap the rest of the yarn around the cardboard to form a cocoon.
- Be sure to cover all of the cardboard. Use the end of the yarn to tie it around a twig.

Butterfly Magnet (Elective 2)

Materials:

- Round coffee filters,
- Watercolor paints or markers,
- Black chenille stem,
- Spray water bottle, magnetic strip (optional)

Directions:

- Lay the coffee filter flat.

- Use watercolor paints or water-soluble markers to draw designs on it.
- Spritz lightly with water until it is slightly damp but not drenched. The colors will bleed some.
- Let dry for a few minutes.
- Fold your chenille stem in half.
- Gather the coffee filter along the center and place it at the bend in your chenille stem.
- Twist the chenille stem shut and then spread out the ends to form antennas.
- Add a magnetic strip to the back of the chenille stem so that you can display your butterfly on the refrigerator

For other **COMPASSION** Character Connection Activities go to -
<http://www.cubroundtable.com/assets/pdf-documents/2002-2010%20Character-Connections-Packet.pdf>

March Crazy Holidays

Jodi, SNJC Webelos Resident Camp Director Emeritus, 2006-2011. Adapted from
<http://holidayinsights.com/moreholidays/index.htm>
<http://www.brownielocks.com/month2.html>

Did you Know? March was named for the Roman God "Mars"

March is



- Irish American Month
- Music in Our Schools Month
- National Craft Month
- National Frozen Food Month
- National Irish American Heritage Month



- National Nutrition Month
- National Peanut Month
- National Women's History Month



- Red Cross Month



- **Adopt A Rescued Guinea Pig Month**
- Berries and Cherries Month
- Deaf History Month (3/13 to 4/15)
- Exotic Winter Fruit & Leeks and Green Onions Month



Natl Honoe Society Natl Junior Honor Soc

- [Honor Society Awareness Month](#)
- National Athletic Training Month
- National Caffeine Awareness Month
- National Eye Donor Month



- National Frozen Food Month
- National Kidney Month

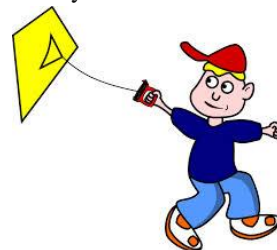

- National Kite Month
- National Multiple Sclerosis Education & Awareness Month
- National Kidney Month
- National Nutrition Month



- National Umbrella Month
- Optimism Month
- Poison Prevention Awareness Month



- [Quinoa Month](#)
- Save Your Vision Month



- Sing With Your Child Month
- Spiritual Wellness Month

Week Celebrations:

- National Cheerleading Week: 1-7
- National Write A Letter of Appreciation Week: 1-7
- Severe Weather Preparedness Week: 1-7
- Celebrate Your Name Week: 1-7
- National Consumer Protection Week: 1-7
- National Procrastination Week: 1-7
- National Sleep Awareness Week: 1-7
- National Words Matter Week: 1-7
- Professional Pet Sitters Week: 1-7
- Save Your Vision Week: 1-7
- [Read an E-Book Week: 1-7](#)
- Return The Borrowed Books Week: 1-7
- Women in Construction Week: 1-7
- Newspaper in Education Week: 2-6
- National School Breakfast Week: 2-6
- Share A Story - Shape A Future Week: 2-6



- **American Crossword Puzzle Wkend: 27-29**
- National Bubble Week 10-16
- Crochet Week 10-16
- **Girl Scout Week: 8-14**
(Always the week with March 12)

- National Agriculture Week: 8-13

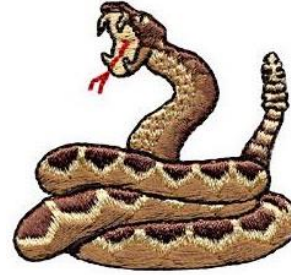

- National Rattlesnake Roundup: 13-15
- Turkey Vultures Return: 11-17
- Flood Safety Awareness Week: 11-15
- Sherlock Holmes Weekend: 15-17



- [Campfire USA Birthday Week: 17-23](#)
(3rd Full Week)
- Consider Christianity Week: 22-28 (Starts the 2nd Sunday Before Easter)
- Health Information Professionals Week: 17-23
- Act Happy Week: 16-22
- American Chocolate Week: 15-21
- Wildlife Week: 16-21



- [International Tree Climbing Days: 21-22](#)
- World Folktales & Fables Week: 16-22
- Pediatric Nurse Practitioner Week: 22-28

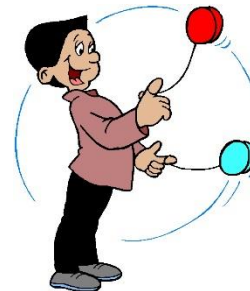

- National YoYo and Skills Toys Days: 14-22



Give Up Meat



- Meat Free Week: 23-29
- National Cleaning Week: 22-28 (Last Week)

March, 2013 Daily Holidays, Special and Wacky Days:

- 1 [National Pig Day](#)
- 1 [Peanut Butter Lovers' Day](#)
- 2 [Old Stuff Day](#)
- 3 [I Want You to be Happy Day](#)
- 3 [If Pets Had Thumbs Day](#)
- 3 [National Anthem Day](#)
- 3 [Peach Blossom Day](#)
- 4 [Holy Experiment Day](#)
- 4 [Hug a GI Day](#)
- 5 [Multiple Personality Day](#)
- 6 [Dentist's Day](#)
- 6 [National Frozen Food Day](#)
- 6 [Employee Appreciation Day](#)
- 7 [National Crown Roast of Pork Day](#)
- 8 [Be Nasty Day](#)
- 8 [International \(Working\) Women's Day](#)
- 9 [Panic Day](#)



- 10 [International Bagpipe Day](#)
- 10 [Middle Name Pride Day](#)
- 11 [Johnny Appleseed Day](#)
- 11 [Worship of Tools Day](#) - guys, you can relate
- 12 [Popcorn Lover's Day](#)
- 12 [Girl Scouts Day](#)
- 12 [Plant a Flower Day](#)
- 13 [Ear Muff Day](#)
- 13 [Jewel Day](#)
- 14 [Learn about Butterflies Day](#)
- 14 [National Potato Chip Day](#)

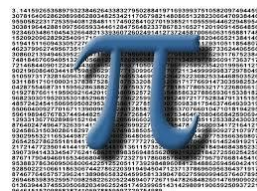

- 14 [National Pi Day](#)- Why today? Because today is 3.14, the value of Pi.
- 15 [Everything You Think is Wrong Day](#)
- 15 [Ides of March](#)
- 15 [Incredible Kid Day](#)
- 15 [Dumbstruck Day](#)
- 16 [Everything You Do is Right Day](#)
- 16 [Freedom of Information Day](#)
- 17 [Submarine Day](#) - the hero sandwich or the boat??
- 17 [Saint Patrick's Day](#)
- 18 [Goddess of Fertility Day](#)
- 18 [National Agriculture Day](#)
- 18 [Supreme Sacrifice Day](#)
- 19 [Poultry Day](#)



- 20 [Earth Day](#)
- 20 [Extraterrestrial Abductions Day](#)
- 20 [Proposal Day](#)
- 21 [National Quilting Day](#)
- 21 [Fragrance Day](#)
- 22 [National Goof Off Day](#)
- 23 [National Chip and Dip Day](#)
- 23 [Near Miss Day](#)
- 24 [National Chocolate Covered Raisin Day](#)
- 25 [Pecan Day](#)



- 25 [Waffle Day](#)
- 26 [National Spinach Day](#)
- 26 [Make Up Your Own Holiday Day](#)
- 27 [National "Joe" Day](#)
- 28 [Something on a Stick Day](#)

- 29 [National Mom and Pop Business Owners Day](#)
- 29 [Smoke and Mirrors Day](#)
- 30 [National Doctor's Day](#)
- 30 [I am in Control Day](#)
- 30 [Take a Walk in the Park Day](#)
- 31 [Bunsen Burner Day](#)
- 31 [National Clam on the Half Shell Day](#)



Note – It appears that National is not updating this in 2015 (and most of 2014). The posted production schedule is for 2013. I will ask some questions. In the meantime enjoy these two former presentations. CD

Experience Oriented Scouting



Every employee and volunteer plays an important role in the development and delivery of life-changing experiences to our members. In this episode of The Buzz, listen to Wayne Brock and Gary Butler discuss the BSA's transition from a member organization to an experience-oriented organization. To learn more, check out this [EOS brochure](#) ..(Click here or below)

Resources

The Link for the brochure is - <http://scout-wire.org/wp->

[content/uploads/2014/05/EOS-Brochure-for-Scout-Wire.pdf](#)

View more episodes of *The Buzz* on BSA's [YouTube channel](#).

Click on the picture above or go to: <http://www.scouting.org/sitecore/content/InternalCommunications/The%20Buzz.aspx>

Get Outdoors with the Camp Scout App



Listen to this video about a phone app to help you find the best places to take your Scouts!!!

Click on the picture above or go to: <https://www.youtube.com/v/ZEXobW1-pP0>

View [the production schedule](#) for *The Buzz*.

BSA SOCIAL NETWORKS



[BSA Facebook page](#)
<https://www.facebook.com/pages/Boy-Scouts-of-America/113441755297>

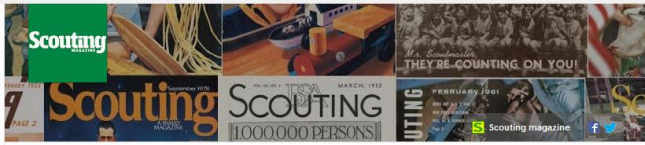

Scouting magazine You Tube Channel
<http://www.youtube.com/user/scoutingmag>

CUBCAST



February 2014 -
 Gathering the Boys for a
 Productive Meeting / Activity

Cub Scouting is fun! Cub Scouting is adventure! Cub Scouting is lots of 8-to-10 year- old boys! So how does one get these rambunctious Scouts settled down so that the meeting or activity can be enjoyed by everyone – including you? Bobby Lester, winner of the Driving Force Award in the Longhorn council in Fort. Worth, Texas, shares some magic tricks and tips you need for a productive activity.

Listen Hear -
http://www.scouting.org/filestore/scoutcast/cubcast/2015021/CC_Feb_Wrangling_Kids.mp3

This is GREAT Advice – Listen to everything he says!!!
 And then read

SCOUTCAST



February 2014 -
 How to Motivate a Scout Along
 the Merit Badge Trail

How do you explain the benefits of merit badges to a boy? Sure, you're the adult, you get it, but how do we explain it so the Scout gets it? And what if all he wants to do is earn the outdoor badges like Camping and Kayaking? How do you pique his interest in ones like Chess, Law, or Reptile and Amphibian Study? Zach Chopp-Adams, advisor for the C2 section of the Michigan Crossroads Council, wrote one of his Wood Badge tickets on motivating Scouts to earn merit badges and shares his insight right here on ScoutCast.

Listen Hear -
http://www.scouting.org/filestore/scoutcast/resources/2015021/SC_Feb_Motivating_Alone_MB_Trail.mp3

It is possible that by the time you get Baloo's Bugle and click the link, there may be a new Cubcast posted. Do not worry, all previous Cubcasts are available from the home page.

Bryans Blog
 January 2015

“Bryan on Scouting” is the official blog of Scouting magazine, a Boy Scouts of America publication. Scouting magazine is published five times a year and is received by 1 million registered adult volunteers.

Bryan covers many topics every month. He keeps his Blog current and deals with the latest issues.

His articles this past month are listed below (Every title has a hyperlink). **The articles in BLUE are of special interest for Cub Scout Leaders.**

Elian’s Good Turn: Scout’s kind act will make you proud to be in Scouting

January 30, 2015 // 12 Comments



If you ever need a reminder that there are still good people in this world, look to Scouting and Elian's Good Turn. This awesome example happened last week.

BSA alternative requirements ensure youth with disabilities get the most out of Scouting

January 29, 2015 // 26 Comments



BRYAN ON SCOUTING
 A Blog for the BSA's Adult Leaders
 CALENDAR OF NEW MERIT BADGES
 CONTACT
 VIDEO
 ASK THE EXPERT
 FORUMS
 SCOUTING MAGAZINE
 HOME
 What's New
 July 25, 2014 in International Scouting // Scouts gather in Curaçao for the 15th Caribbean Jamboree

[BSA alternative requirements benefit Scouts or Venturers with documented disabilities. So they can be a Cub Scout past age 11 and a Boy Scout past 18.](#)

12 Eagle Scouts with Super Bowl ties

January 28, 2015 // 48 Comments



I found at least 12 Eagle Scouts with Super Bowl ties, include a New England Patriots offensive lineman and the president of the Seattle Seahawks.

Scouts, Venturers give a 3-D-printed hand to kids in need

January 28, 2015 // 5 Comments



Scouts and Venturers in Baltimore are making 3-D-printed hands to send to refugees and others in need around the world.

Matt Moniz: Eagle Scout, superstar climber, Outdoor Inspiration Award winner (and he's just 16)

January 27, 2015 // 8 Comments

Matt Moniz, Eagle Scout and superstar climber, added one more honor to his ever-lengthening résumé: Youth winner of the Outdoor Inspiration Award.

Honor Guard patch now available for Boy Scouts

January 27, 2015 // 107 Comments



For years, Boy Scout Honor Guards have added reverence, dignity and patriotism to events. Now there's an Honor Guard patch to recognize this important role.

Top 5 merit badge books to get you ready for this blizzard (and the next)

January 26, 2015 // 27 Comments

With a blizzard on the way, check out five Boy Scout merit badge books to help you get through unscathed.

Seattle Seahawks President Peter McLoughlin is an Eagle Scout

January 26, 2015 // 6 Comments



Long before leading the Seattle Seahawks to the Super Bowl in back-to-back seasons, Seahawks president Peter McLoughlin became an Eagle Scout.

Watch this: 'A Brief History of Cub Scouting'

January 23, 2015 // 12 Comments



The three-minute video's title — "A Brief History of Cub Scouting" — says it all. It's a nice overview for new Cub Scouters and Cub Scouting veterans alike.

Cloud control: Digitizing medical records? BSA says please don't

January 23, 2015 // 126 Comments



Digitizing medical records is a no-no, BSA says. Records are not to be digitized, scanned, sent by email or stored electronically by unit.

Missed the Cub Scout webcasts? Here's how to get up to speed

January 22, 2015 // 28 Comments

**REAT CHANGE H/
LWAYS HAPPENE
N CUB SCOUTINI**

Couldn't tune in to the Cub Scout webcasts? Use the links here to view the webcasts at your convenience and get up to speed.

Scout Sunday 2015 is Feb. 8 — here's how to celebrate

January 22, 2015 // 18 Comments



[On Scout Sunday 2015 — Feb. 8 — uniformed Scouts and Scouters will greet the congregation, participate in worship services and receive religious awards.](#)

Inside the next-gen program features for troops, teams and crews

January 21, 2015 // 33 Comments

The three-volume Program Features for Troops, Teams and Crews is your youth leaders' go-to resource for planning a fun and engaging program.

Tuesday Talkback: Share your troop meeting schedule

January 20, 2015 // 40 Comments

The opening ceremony opens the meeting, and the closing ceremony closes it. But what happens between? Share your troop meeting schedule here.

Scout saves a life, gets featured on 'The Meredith Vieira Show'

January 16, 2015 // 16 Comments



A day of fun hiking in the Great Smoky Mountains for Laurie Leslie and her son Devon turned into a nightmare. Good thing Boy Scout Emery Benson was there.

Boys' Life magazine: Kid tested, parent approved

January 16, 2015 // 13 Comments



[For the third year in a row, Boys' Life magazine has earned a coveted Parents' Choice Approved Award.](#)

Eagle Scout: Scouting is 'the last real experience someone my age can have'

January 16, 2015 // 26 Comments



So much in life these days is simulated that something real and authentic stands out. Thank goodness for Scouting, says Eagle Scout Steven Madigan.

Martin Luther King Jr. was a Boy Scout

January 15, 2015 // 133 Comments



[The rumors are true: Martin Luther King Jr. was a Boy Scout. He was registered as a member of Troop 151, which met at Ebenezer Baptist Church.](#)

Here's how Eagle Palms work

January 14, 2015 // 47 Comments

Eagle Scouts can earn one Eagle palm for every five merit badges beyond the 21 required. He can earn Eagle palms as quickly as one palm every three months.

How the BSA views unauthorized use of the Scout uniform by non-Scouts

January 14, 2015 // 86 Comments

The Boy Scouts of America's symbols, including the Scout uniform you wear every week, are protected under U.S. trademark law. Here's what that means.

Scouts, National Geographic team up to save animals

January 13, 2015 // 0 Comments



For the National Geographic Mission: Animal Rescue Contest, Scouts demonstrated how they help save the lives of animals and educate others about nature.

BSA discourages use of unofficial merit badge worksheets

January 13, 2015 // 140 Comments



Unofficial merit badge worksheets hasten the process of earning a merit badge, but are they allowed or encouraged by the Boy Scouts of America?

Meet Matthew Failor, an Eagle Scout competing in the next Iditarod

January 12, 2015 // 9 Comments

Eagle Scout Matthew Failor credits Scouting with preparing him for the hardships of the Iditarod Trail Sled Dog Race, kicking off March 7.

Race to your nearest Lowe's for Dremel Pinewood Derby Days

January 12, 2015 // 16 Comments



Want to give your son an edge in your pack's upcoming Pinewood Derby race? Head to your nearest Lowe's for Dremel Pinewood Derby Days.

Scouts brave 'Misery Campout' in subzero weather for coveted clear bead

January 10, 2015 // 42 Comments



Sometimes Troop 707 Scouts get only a few hours notice before heading out for the coldest weekend of the year. It's called the Misery Campout.

Does Cub Scouting really improve a boy's character?

January 9, 2015 // 22 Comments



Cub Scouting can improve the character of boys, according to new research from Tufts University doctoral candidate Dan Warren.

So awkward: How to handle difficult conversations with Scouts and Venturers

January 9, 2015 // 21 Comments



Talking to your teenage Scouts and Venturers about awkward topics isn't easy. Here's help.

2014 November-December 'Where Am I?' winner, location revealed

January 8, 2015 // 3 Comments



Did you cast a vote in the 2014 November-December "Where Am I?" Contest? See if you were selected as the lucky winner, and check out the newest geography contest.

Maroon 5 guitarist James Valentine is an Eagle Scout

January 8, 2015 // 5 Comments



James Valentine, guitarist for the Grammy-winning band Maroon 5, is an Eagle Scout.

Friendly reminder: Don't miss the Cub Scout webcasts on Saturday, Jan. 17

January 7, 2015 // 11 Comments

On Saturday, Jan. 17, the hourlong Cub Scout webcasts will cover the coming changes, how to prepare and when resources will be available

Six Eagle-required merit badge pamphlets now available in Spanish

January 6, 2015 // 18 Comments

For the first time in BSA history, six Eagle-required merit badge pamphlets are available in Spanish.

Become a charter member of the Summit Bechtel Reserve Staff Association

January 5, 2015 // 11 Comments

Current and former Summit Bechtel Reserve staffers are invited to become charter members of the Summit Bechtel Reserve Staff Association.

Blog Contributors

[Bryan Wendell](#), an Eagle Scout, is senior editor of *Scouting* and *Eagles' Call* magazines.



Gretchen Sparling is associate editor of *Scouting* and *Eagles' Call* magazines.

Get Email Updates

To sign up to receive Bryan's Blog in your E-mail – Click the link that appears in every article. Bryan and Gretchen promise never to sell or otherwise exploit your email address. Join 6,162 other subscribers

Training Topics

Cubmaster for Dummies

*Sean Scott,
Roundtable Commissioner Emeritus,
Inland Empire Council*

The best advice I ever received on being a Cubmaster was simple and to the point:

“POOF! You're nine. Act like it. Think like it.”

While some of the most successful Cubmasters I've ever met were natural nine-year-olds, there is no reason that a fully-grown adult can't do an equally good job. It just takes a little more practice and preparation!

The monthly pack meeting is the biggest, most important job of the Cubmaster, yet many have a hard time getting it right. I've run and observed a lot of pack meetings, both good and bad, and noticed what works and what doesn't. Interestingly, good packs, with lots of involved and motivated parents and leaders, are often the packs that have great pack meetings! They set the tone for the entire pack program!

The first thing you should do to improve your pack meeting is to stop having them altogether. Eliminate the word “meeting” from your Scouting vocabulary. “Meeting” has too many negative meanings for most of us. You go to a meeting to discuss things, learn about the latest layoffs, or have more work assigned. Meetings are dull. Nobody looks forward to meetings.

On the other hand, everybody likes to be entertained. So instead, focus on presenting a “Pack Performance” every month! That is a much better description of what your monthly gathering is—a show! Every month represents a one-night-only premiere, and as the Cubmaster, you and your cast are the producers, writers, directors and master of ceremonies!

Now that you have the right frame of mind, what should your performance contain? Make it interesting to both boys and the adults. If it isn't, one or the other will stop paying attention and you'll lose control. The show should appeal to the boys, but be fine-tuned for the adults. The overall program should be short and entertaining, and each act should be as brief as possible within the larger show. Keep it loud, visual and dynamic. Physiologically, boys have short attention spans,

process information visually, and don't hear a good percentage of what is said to them. (Read Michael Gurian's "Wonder of Boys" for details on this, gentleman. The ladies already know men don't listen!)

Plan an even mixture of skits, run-ons, songs, ceremonies and games. Use costumes, props and decorations for atmosphere and visual appeal. Involve parents and leaders in the program. Sprinkle brief, informative moments throughout the show, but work on eliminating gaps, pauses, extensive preparations, long speeches, or readings.

No performance has announcements. Instead, print up a monthly newsletter with all the important information that parents and boys need to know, and make sure that everyone gets a copy. What you may find useful is to print a calendar for the coming month on one side of your newsletter, which will invariably find its way to the refrigerator doors of most families in your pack. It is better to remind parents of an event every time they reach for the milk, than to read the date out to the group during your performance. I guarantee that nobody will memorize it, and few will write it down! With the newsletter going out to all the families, you can instead concentrate on quickly pointing out how fun and exciting the coming month will be, without going into boring details.

You should also avoid having any single act deal exclusively with one boy or one den for too long, especially during recognition ceremonies. If you're handing out awards to Den 2, nobody but Den 2 will be paying attention. Instead, try to incorporate the entire pack into your recognition segments. Boys and parents alike will soon realize that their name could come up at any moment and pay closer attention to your program, instead of gossiping or goofing off!

Finally, pull parents and leaders, boys and siblings into the program. No matter how naturally entertaining you may be, a one-man show gets old after a while! Use older siblings to help with lighting, stage setup, and ceremonies. Involve parents and boys in skits and run-ons. And get your entire audience into the act with songs and audience participation stunts. Personally, I use two assistant Cubmasters: one is my partner in crime, and one is my "announcement person" (and better half). I'll recruit one or two other leaders, one or two parents, a few older siblings, and one den each month to help out. All the adults and siblings get a script that we write on the Saturday before the meeting, based on a general plan we hash out the week before over the phone and through email. In all, it takes a couple of hours to write, and another couple to gather everything together. We'll scatter run-ons, skits and songs between the segments that take more preparation to prevent lulls while we prepare for them.

So what if it's been a long time since you were nine, and you've forgotten what it was like? What is the secret to being a great Cubmaster?

As the Cubmaster you should plan on making a fool of yourself, because it has ageless appeal—kids and adults alike are inexplicably mesmerized and amused by a grown man or woman performing "Tooty-Ta", talking in a weird accent, or otherwise embarrassing themselves. It means you need to plan and practice your show, and most of all, have no pride.

Being loud enough to be heard without a microphone is helpful!

You should also think back to what it was like to pretend. Remember, as a kid, how you could turn a cardboard box into a house, racecar, space capsule, submarine or jet fighter with just a few quick crayon marks? That's the idea! "Let's Pretend" are two mighty powerful words! Your props and costumes don't have to be the quality of a major motion picture set, just enough to get the idea across! We use lots of props and costumes, even if it's just a bandana over the face and a sign hung around someone's neck that says "Bank Robber."

I don't claim to be the ultimate Cubmaster, or an expert by any means, but I can count on one hand how many times I've needed to put up the Cub Scout sign at a meeting. These methods work for me, and I've seen them work for others. The boys tell me they're always wondering what's going to happen next, and the parents tell me they can't believe that we did some goofy, silly thing. They pay attention (and show up on time) because they don't want to miss something, and are excited about what's coming up next.



PROGRAM UPDATE

**Watch this:
'A Brief History of
Cub Scouting'**

From:

BRYAN ON SCOUTING

A Blog for the BSA's Adult Leaders

Posted on January 23, 2015 by Bryan Wendell



One of the many highlights of [Saturday January 17th's informative Cub Scout webcasts](#) was the opening video.

The title of the three-minute piece — "A Brief History of Cub Scouting" — says it all. It's a nice overview for new Cub Scouters and Cub Scouting veterans alike.

Take a look:



Click the picture or go to:

<https://www.youtube.com/watch?v=ogc94pF1U5U>

**Missed the Cub Scout webcasts?
Here's how to get up to speed**

**GREAT CHANGE HAS
ALWAYS HAPPENED
IN CUB SCOUTING**

From:

BRYAN ON SCOUTING

A Blog for the BSA's Adult Leaders

Posted on January 22, 2015 by Bryan Wendell



Thousands of your fellow Scouters watched the Cub Scout webcasts last weekend, and in doing so they left with a greater knowledge of the [incredible changes coming to Cub Scouting this year](#).

Couldn't tune in? No worries.

Use the links below to view the webcasts at your convenience. In half an hour, you'll get up to speed on the

new Cub Scout program and learn some recommended next steps.

I thought the webcasts were enjoyable and informative. They kept the focus where it belongs: Making the Cub Scout experience meaningful and fun for boys.

Here's how to watch the webcasts and what to do after you watch.

Watch the Cub Scout webcasts

Cubmaster Video –

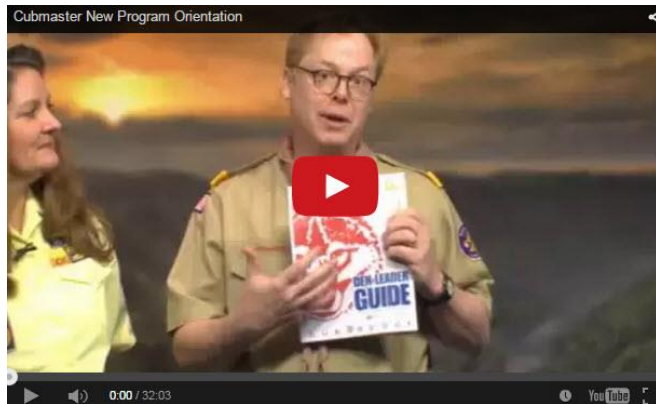

Click the picture or this link:

<https://www.youtube.com/watch?v=J3seP16x-L0>

Den Leader Video



Click the picture or this link:

<https://www.youtube.com/watch?v=eD4PHvSWq70>

LDS Video -



Click the picture or this link:

<https://www.youtube.com/watch?v=Jo-XFt8r3D4>

Next steps

- **Find roundtable content, handouts, requirements** and tons of Cub Scout content at the BSA's useful [Program Updates page](#).
- **Begin unit annual planning now.** All of the information needed, including requirements, are available now at that same Program Updates page.
- **Stay in touch with your roundtables,** and know that even more supplemental information is coming. Don't wait to plan, though!
- **Don't keep this info to yourself.** Please share what you know with your fellow Scouters. If you're a district- or council-level volunteer or professional, please spread the word.
- **Watch for program materials** coming May 1 in English and Spanish. They'll be available in Scout shops and online.

Attendance numbers

So how many Scouters gave up part of their Saturday to watch the webcasts? Tens of thousands.

I'm told there were more than 17,300 connections to the webcasts throughout the day, but the real number of viewers is exponentially higher.

That's because several groups of Scout leaders gathered at watching parties. A group of three or five Scouters gathered together around a computer counts as just one connection.

Tip of my cap (From Bryan)

Congrats to the entire team behind these great webcasts, including volunteers Nancy Ferrell, Ken King, and Linda Vaughn and professionals Bob Scott and Darin Kinn.

ROUNDTABLE UPDATES

National is publishing seven (*there is that number again!!! – 7 Adventures per Rank, 7 parts to every meeting in Cub Scouting- Den Meetings, Pack meetings, Rooouunndtables!!!*) information packets with updates on the new **Adventure Program**. These sessions are intended to replace the Interest Topic sessions in the current (2014-2015) Cub Scout Roundtable planning Guide All sessions will be available on the Program Updates page.

Two have been published

January – Program Support for Den Leaders

February – Advancement

The remainder are:

March Program Planning for Dens

April New Pack Meeting Plans

May Aquatic Adventures

June Campfire Programs

July Resources for Packs and Den Leaders

If your Roundtable is not presenting this material, please politely ask your RT Commissioner to do so.

The next update will be posted at www.scouting.org/programupdates during the final week of the month prior to the RT at which it is supposed to be presented.

TRAINING ON THE ADVENTURE PROGRAM

Want to learn all about this - The course to look for is:

Leading the NEW Cub Scout Adventure

Are you ready for an adventure? During this fun-filled week you will experience the NEW Cub Scout Adventure program from Tiger through Arrow of Light and learn what it takes to lead and support the program delivery.

This is a "hands-on" conference providing perspective on leading the new program from multiple roles. Participants will experience the excitement of being a Cub Scout as they learn about the new Cub Scout adventures and trek through each of the ranks, learn about the latest and greatest in Pack Meeting Plans, and use den and pack planning tools to better deliver the program.

Attendees in service to units (professionals, commissioners, and others) will share this journey while following their own path, learning how districts and councils can support local units in the delivery of this NEW and EXCITING program for Cub Scouts. You won't want to miss this one!

The course is offered

- * Week 3: June 21-27,
- * Week 6: July 12-18,
- * Week 8: July 26-August 1,
- * Week 9: August 2-8

When you go to the website be sure to check out the fantastic Family programs brochure and the wonderful things they will do with the rest of your family (spouses, kids, grandkids, ...) while you are in the learning seminars.

Get the **Family Program brochure** at - <http://www.philmontscoutranch.org/filestore/philmont/pdf/PTCFamily.pdf>

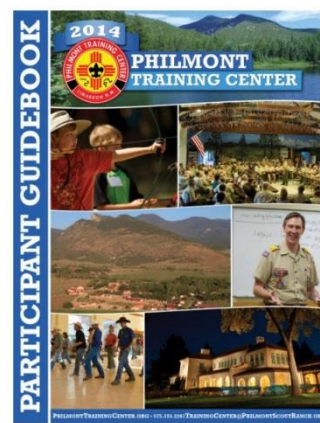
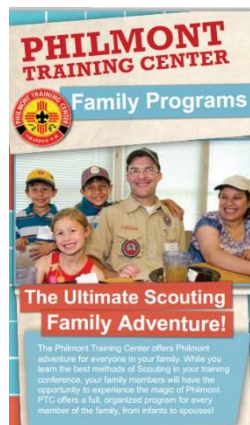

Also, checkout the **PTC Conference Guidebook** at - <http://www.philmontscoutranch.org/filestore/philmont/pdf/PTC8PGO.pdf>



Tiger Requirements (2015-2016 Program Year)

1. Complete each of the following Tiger required adventures with your den or family:
 - a. Backyard Jungle
 - b. Games Tigers Play (*You can get all the details on this one from the sample Books. It is the Tiger example from the Boy's Book* (http://www.scouting.org/filestore/program_update/pdf/220-851_LO.pdf) and the Den Leader's Book (http://www.scouting.org/filestore/program_update/pdf/220-852_LO.pdf))
 - c. My Family's Duty to God (*This Adventure is done at home with Family members*)
 - d. Team Tiger
 - e. Tiger Bites (**Food & Nutrition**)
 - f. Tigers in the Wild
2. Complete one Tiger elective adventure of your den or family's choosing.
3. With your parent or adult partner, complete the exercises in the pamphlet How to Protect Your Children From Child Abuse: A Parent's Guide, and earn the Cyber Chip award for your age.*
 - * If your family does not have Internet access at home AND you do not have ready Internet access at school or another public place or via a mobile device, the Cyber Chip portion of this requirement may be waived by your parent or adult partner.

Match the pictures to the Adventures –



Answers – 1e, 2f, 3c, 4a, 5d, 6b

going on with his den—as a Wolf in the Tiger handbook, as a Bear in the Wolf handbook, and as a Webelos Scout in the Bear handbook. And as they work toward their Webelos and Arrow of Light ranks, they will catch glimpses of the fun awaiting them as they transition to Boy Scouts. Look for more on Ethan on the program updates page as we get ready to introduce him in 2015! www.scouting.org/programupdates



See all the steps for every adventure in the



2015-2016
Cub Scout
Requirements

PDF located on the Program Updates page –
www.scouting.org/programupdates

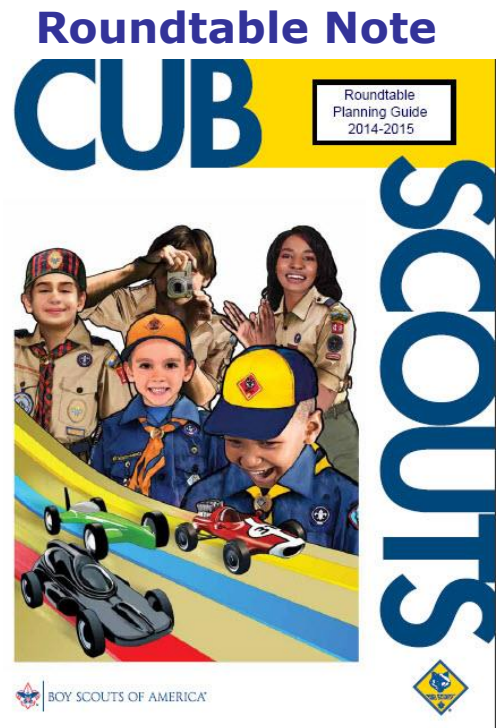

Who Is Ethan?



In 2015, Cub Scouts will get to know a new member of the Cub Scout team—Ethan! Ethan is a Cub Scout who will guide Scouts through each rank in the new Cub Scout program. He'll appear in each adventure in their new handbooks, and he will always be a year older and one rank ahead of the Scouts. As Cub Scouts learn a new skill, they'll look to Ethan for encouragement, helpful tips, funny stories, and even some mistakes he's made (and learned from) along the way. Ethan might not be perfect, but he does his best and has a great time with his Scouting friends. Boys can aspire to the increasingly exciting adventures Ethan is



The RT Planning Guide Task Force has been formed and is working hard to finalize the 2015-2016 edition.

We are strengthening the Big Rock Topics, Cub Scout Interest Topics, adding discussion guides for Monthly Pack Activities, and improving many other features.

The **Working** titles of the 12 Themes and their related Core Values to be highlighted in the 2015-2016 CS RT Planning Guide (**The names are not all final at this time - some are still under review by BSA**):

RT Month	Prog Month	Point of the Scout Law	Theme
Aug 2015	Sep 2015	Clean	Cubservation
Sep 2015	Oct 2015	Brave	Super Cub!
Oct 2015	Nov 2015	Helpful	Cubs In Action
Nov 2015	Dec 2015	Reverent	Winter Wonderland
Dec 2015	Jan 2016	Trustworthy	The Great Race
Jan 2016	Feb 2016	Friendly	Friends Near and Far
Feb 2016	Mar 2016	Thrifty	Cubstruction
Mar 2016	Apr 2016	Cheerful	Strike Up the Band
Apr 2016	May 2016	Kind	My Animal Friends
May 2016	Jun 2016	Obedient	It's a Hit
Jun 2016	Jul 2016	Loyal	Scout Salute
Jul 2016	Aug 2016	Courteous	S'more Cub Scout Fun

Suggestions and comments can be sent to Dan Maxfield. Dan is the RT member of Tico's National Support Staff. His E-mail is dmaxfil@yahoo.com

Commissioner Dave is working on the team this year after two years as the lead, he requested a break. His E-mail is davethecommish@gmail.com

The Parable of the Pencil

Rev Doug Baitinger, Mantua (NJ) UMC

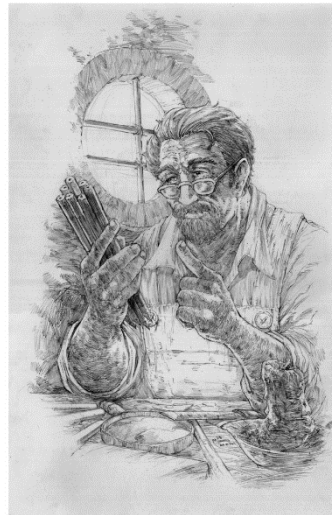

The Pencil Maker took the pencil aside, just before putting him into the box. "There are 5 things you need to know," he told the pencil, "Before I send you out into the world. Always remember them and never forget, and you will become the best pencil you can be."

- ✓ **“One:** You will be able to do many great things, but only if you allow yourself to be held in someone else’s hand.”
- ✓ **“Two:** You will experience a painful sharpening from time to time, but you’ll need it to become a better pencil.”
- ✓ **“Three:** You will be able to correct any mistakes you might make.”
- ✓ **“Four:** The most important part of you will always be what’s inside.”
- ✓ **“And Five:** On every surface you are used on, you must leave your mark. No matter what the condition, you must continue to write.”

The pencil understood and promised to remember, and went into the box with purpose in its heart.

Now let’s try replacing the pencil with a Scout!

Always remember them and never forget, and you will become the best Scout you can be.

- ✓ **One:** You will be able to do many great things, but only if you allow your leader's hand to hold and lead you. Be it Akela (for Cubs) or the Scoutmaster or others.
- ✓ **Two:** You will experience a painful sharpening from time to time, by earning badges and not taking the easy road. You need to do it to become a stronger person.
- ✓ **Three:** You will be able to correct mistakes you make. You can repitch the tent or apologize to others.
- ✓ **Four:** The most important part of you will always be what’s on the inside. Do your best.

- ✓ **And Five:** On every surface you walk, you must leave your mark by helping others along the Scouting Trail.

Now let's try replacing the pencil with you and your life!

Always remember them and never forget, and you will become the best person you can be.

- ✓ **One:** You will be able to do many great things, but only if you allow yourself to be held in God's hand. And allow other human beings to access you for the many gifts you possess.
- ✓ **Two:** You will experience a painful sharpening from time to time, by going through various problems, but you'll need it to become a stronger person.
- ✓ **Three:** You will be able to correct any mistakes you might make. You will be forgiven.
- ✓ **Four:** The most important part of you will always be what's on the inside in your heart and soul.
- ✓ **And Five:** On every surface you walk through, you must leave your mark. No matter what the situation, you must continue to do your duties.

How about replacing the pencil with you as a Leader?

By understanding and remembering, let us proceed with our life on this earth having a meaningful purpose in our heart. We all need to be constantly sharpened as leaders:

- ✓ **One,** allow yourself to be guided by mentors, career coaches and trusted friends and colleagues.
- ✓ **Two and Three,** never allow yourself to get discouraged and think that your life is insignificant or can't be changed. Like the pencil, the most important part of who you are is what is inside of you.
- ✓ **Four,** may this parable encourage you to know that you are a special person with unique talents and abilities.
- ✓ **And Five,** only you can fulfill the purpose which you were born to accomplish.



The Parable of the Pencil, parts 2 & 3

Rev Doug Baitinger, Mantua (NJ) UMC

The Parable of the Pencil - Part 1 Review from last month

The five things the pencil maker told the pencil -

- ✓ **One:** You will be able to do many great things, but only if you allow yourself to be held in someone else's hand.
- ✓ **Two:** You will experience a painful sharpening from time to time, but you'll need it to become a better pencil.
- ✓ **Three:** You will be able to correct any mistakes you might make.
- ✓ **Four:** The most important part of you will always be what's inside.
- ✓ **And Five:** On every surface you are used on, you must leave your mark. No matter what the condition, you must continue to write.

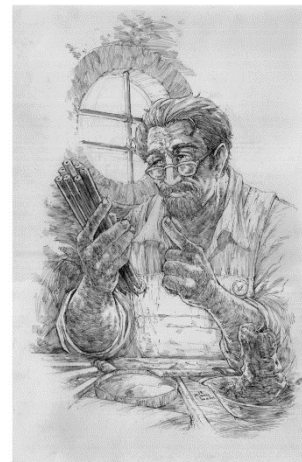

The Parable of the Pencil - Part 2

But now the pencil lay on the dark wood table, feeling insignificant and rather sad. Beside him on the desk was a colorful tin can, filled with every kind of beautiful pen to be had. There were silver fountain pens and a neon felt tip marker. There was also a classy ballpoint whom everyone called Parker.

"What a loser," they said of the pencil, as they observed his wooden frame.

"Don't bother with him, he's a nobody," said Parker, "He doesn't even have a name."

Now the world was at war and their owner was a Soldier who was tasked to bring peace to the land. "What we need is a map," the Soldier had said, at the desk across from his Officer the other night. "If someone can fly me

over the city unseen, I can draw a map from the sky. The map will tell you where to go and how to win, and soon we'll put an end to this fight." The Officer had agreed and now the Soldier would fly, but first he discussed with his wife. "I'll need something to draw with, something dependable... something that won't fail me mid-flight."

The Soldier looked at his dark wood desk, and observed all the pens in the can. He studied each one, their bodies all shimmering, and he weighed them all in his hand. "This one won't work," he said of a pen, "the ink might blot on the map. This one needs to be refilled every few hours, and this one will dry out without a cap." He looked at each one and always found something wrong or anticipated problems if he used it in the sky. "I need something that would work whatever the conditions, and I need it soon my dear wife."

"Then take this pencil." his wife finally said, handing him the frail and battered yellow thing. "It will write no matter what, it will write on a plane - it's the best writing tool you can bring."

The Soldier smiled, kept the pencil in his pocket, and took it with him on the plane. He finished the map and the map helped bring them peace... and the pencil has never been the same.

The Parable of the Pencil - Part 3

The pencil was now nothing more than a stub; what was left of his lead was now broken. His eraser was gone, his wood frame had split, and some time ago his metal ring had been stolen.

Now he stood before the Pencil Maker, and waited for him to say those 5 words.

"Well done, my faithful pencil," the Pencil Maker said, "You have written what you were meant to write in the world."



THOUGHTFUL ITEMS FOR SCOUTERS

Thanks to Scouter Jim from Bountiful, Utah, who prepares this section of Baloo for us each month. You can reach him at bobwhitejonz@juno.com or through the link to write Baloo on www.usscouts.org. CD

Prayer

Great Father above, ruler of heaven and earth, we come to Thee grateful for the bounties of Thy hand. Please bless us to share of those gifts given unto us with others in need. Bless our eyes to see where we can lift a brother or sister and be Thy hands here on Earth. Bless those who need help we cannot see, and lead someone to them. Amen

And the King shall answer and say unto them, Verily as ye have done it unto the least of these my brethren,
[Matthew 25:40 KJV New Testam](#)

Still Protecting and Serving Scouter Jim, Bountiful, UT

While making my daily two block commute from the Bus Stop to the building where I work one morning in a pouring rain, I passed two young women, walking toward my direction. Behind them in full dress uniform, a young United State Marine, holding an umbrella above the women's heads. He himself was taking the full force of the rain, but the smiled and said hello as we passed. He walked as proud and upright as if he was guarding the President of the United States, and yet he was protecting two women, whom he probably did not know. My first internal reaction was to bring my arm up in a Boy Scout salute and salute him as he passed, but I did not.

Both I and my companion were impressed with this simple act of true manhood and compassion. He did not need to know those he was protecting to do his duty.

One of the principals of the Marines is "Lead by example." This young marine gave the greatest example of compassion I have seen in a very long time. May God bless and protect him and I salute this unknown marine.

Quotations

Do what you can with what you have
[President Theodore Roos](#)

Quotations contain the wisdom of the ages, and are a great source of inspiration for Cubmaster's minutes, material for an advancement ceremony or an insightful addition to a Pack Meeting program cover

The dew of Compassion is a tear [Lord Byron](#)

Compassion is the antitoxin of the soul: where there is compassion even the most poisonous impulses remain relatively harmless. [Eric Hoffer](#)

By compassion we make others' misery our own, and so, by relieving them, we relieve ourselves also. [Thomas Browne](#)

The human spirit is not dead. It lives on in secret... It has come to be believed that compassion, in which all ethics must take root, can only attain its full breadth and depth if it embraces all living creatures and does not limit itself to mankind. [Albert Schweitzer](#)

I believe in human dignity as the source of national purpose, human liberty as the source of national action, the human heart as the source of national compassion, and in the human mind as the source of our invention and our ideas. [President John F. Kennedy](#)

If you haven't any charity in your heart, you have the worst kind of heart trouble. [Bob Hope](#)

I always prefer to believe the best of everybody, it saves so much trouble. [Rudyard Kipling](#)

There is no greater loan than a sympathetic ear. [Frank Tyger](#)

How far you go in life depends on your being tender with the young, compassionate with the aged, sympathetic with the striving and tolerant of the weak and strong. Because someday in your life you will have been all of these. [George Washington Carver](#)

Too often we underestimate the power of a touch, a smile, a kind word, a listening ear, an honest compliment, or the smallest act of caring, all of which have the potential to turn a life around. [Leo Buscaglia](#)

A single act of kindness throws out roots in all directions, and the roots spring up and make new trees. [Amelia Earhart](#)

Beginning today, treat everyone you meet as if they were going to be dead by midnight. Extend to them all the care, kindness and understanding you can muster, and do it with no thought of any reward. Your life will never be the same again. [Og Mandino](#)

The true meaning of life is to plant trees, under whose shade you do not expect to sit. [Nelson Henderson](#)

I expect to pass through life but once. If therefore, there be any kindness I can show, or any good thing I can do to any fellow being, let me do it now, and not defer or neglect it, as I shall not pass this way again. [William Penn](#)

Always be a little kinder than necessary. [James M. Barrie](#)

Colonel Gail S. "Hal" Halvorsen" The Candy Bomber – Uncle Wiggle Wings

In the 14 Chapter of Matthew in the New Testament, Jesus Christ feeds more than five thousand people with two fishes and five loaves of bread. This story is how two pieces of gum became thousands of tons of candy.

Gail S. Halvorsen was born on October 10, 1920 in Salt Lake City, Utah. He got a private pilot license in September 1941 and joined the Civil Air Patrol as a pilot. With the outbreak of World War

He joined the United States Army Air Corps in June 1942 and was sent to train with the Royal Air Force as a fighter pilot.

After completing his training he returned to the Army Air Corps assigned to foreign transport operation in the South Atlantic.

The end of World War II brought a divided Germany and in 1948 the Soviet Union blockaded West Berlin inside Soviet controlled East Germany. During this time American and British pilots delivered more than two million tons of supplies to the city.

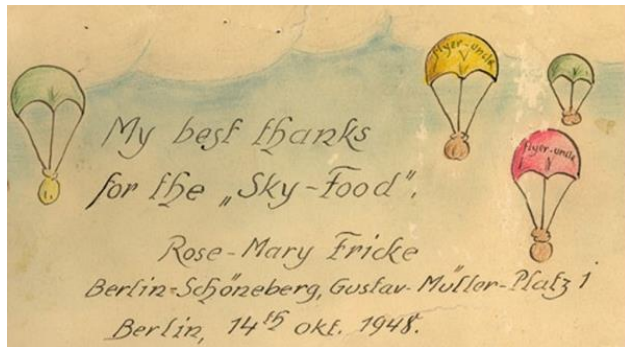

Below is Gail Halvorsen's account of what happened:

The Airlift was not just an Air Force operation. The Army and Navy were also heavily involved. The Navy had two top flight squadrons of R-5Ds (C-54s) and had the vital Sea Lift across the Atlantic. The Army had many roles but the greatest was moving everything on the ground. America was not alone. The British and French were partners.

On that first flight to Berlin I was deep in thought. Hitler began this war of destruction. It had interrupted the orderly progress of my life. Now I was 27 years old. I should have had one or two children by now. Instead I wasn't even engaged to be married. Several of my buddies had returned from the war to see their previously conceived child for the first time. Many did not return. They would not see their newborn child in this life. My close

friend, Conrad Stefen from Tremonton, Utah was still missing. I had interested him in being a pilot by flying him in my J-3 Cub before the war. Maybe his remains were somewhere under the flight path I had flown that very day, on my way from Frankfurt to Berlin. He had been shot down three years before in his P-47 Thunderbolt.

We had just left the security and comfort of life in America. We were beginning to get our lives back to normal after the war. Now, here we were flying night and day in all kinds of weather; living in tents and tar paper shacks that had housed Hitler's Displaced Persons work gangs. As for me my bed was in the attic of a farmer's old barn in Zepplinheim! We had left for Germany so fast I had to drive the first new car of my life under the trees in Mobile Alabama, put the keys in my pocket, look back once and leave. I would never see that new, red, four door Chevy again.

How did the ground and flight crews feel after this second disruption of their lives occasioned by what Hitler began?

Those of us who stayed in the military after the war already knew that the enemy and threat to the West was now Stalin and his Soviet Union. They wanted Berlin and West Germany. They had just taken Czechoslovakia and Hungary. West Berlin was next. We knew that Berlin was populated by mostly women and children. When word came that Stalin had cut off all the food and energy supplies to these suffering people this assignment became a worthwhile challenge. But that didn't make this second disruption without some pangs of doubt.

However these last feelings of doubt left me when I landed that

first load of 20,000 pounds of flour at Tempelhof in West Berlin. The German unloading crew poured through the open cargo door in the back of my aircraft. The lead man came toward the cockpit, moist eyes hand out thrust in friendship. Unintelligible words but his expression said it all. He looked at the bags of flour and back to us like we were angels from heaven. People were hungry for food and freedom. We were giving them both and they were most grateful. Gratitude is the magic potion that makes enemies friends and seemingly impossible tasks doable. From then on the pangs of doubt were gone.

One of my fellow Airlift pilots had bombed Berlin during the war. I asked him how he felt about flying day and night on behalf of the enemy, the very ones who did their best to kill him as he flew over Berlin in 1944. He hesitated a moment, shuffling his feet and then said, "It feels a lot better to feed them than it does to kill 'em." I only knew of one person who complained of flying day and night in behalf of the former enemy. This I believe was because of the overt expression of gratitude by the West Berliners. Everyone feels peace in their heart when they serve others. This was the case even though the "others" were the former enemy.

One day in July 1948 I met 30 kids at the barbed wire fence at Tempelhof in Berlin. They were excited. They said, "When the weather gets so bad you can't land don't worry about us. We can get by on little food but if we lose our freedom we may never get it back." The principle of freedom was more important than the pleasure of enough flour. "Just don't give up on us," they asked. The Soviets had

offered the Berliners food rations but they would not capitulate. For the



hour I was at the fence not one child asked for gum or candy. Children I had met during and after the war like them in other countries had always begged insistently for such treasures. These Berlin children were so grateful for flour to be free they wouldn't lower themselves to be beggars for something more. It was even the more impressive because they hadn't had gum nor candy for months. When I realized this silent, mature show of gratitude and the strength that it took not to ask, I had to do something. All I had was two sticks of gum. I broke them in two and passed them through the barbed wire. The result was unbelievable. Those with the gum tore off strips of the wrapper and gave them to the others. Those with the strips put them to their noses and smelled the tiny fragrance. The expression of pleasure was unmeasurable. I was so moved by what I saw and their incredible restraint that I promised them I would drop enough gum for each of them the next day as I came over their heads to land. They would know my plane because I would wiggle the wings as I came over the airport. When I got back to Rhein-Main I attached gum and even chocolate bars to three handkerchief parachutes. We wiggled the wings and delivered the goods the next day. What a jubilant celebration.

We did the same thing for several weeks before we got caught, threatened with a court martial which was followed by an immediately a pardon. General Tunner said, "Keep it up."

Letters came by the hundreds. A little girl, Mercedes, wrote that I scared her chickens as I flew in to land but it was OK if I dropped the goodies where the white chickens were. "When you see the white chickens, drop it there. I don't care if it scares them." I couldn't find her chickens so I mailed her chocolate and gum through the Berlin mail. Twenty two years later, 1970, I was assigned as the commander of Tempelhof. One letter kept asking us to come to dinner. In 1972 we accepted. The lady of the house handed me a letter dated November 1948. It said, "Dear Mercedes I can't find your chickens. I hope this is OK. Your Chocolate Uncle." I had attached a box of candy and gum. The lady said, "I am Mercedes step over here and I will show you where the chickens were." My family and I have stayed with Mercedes and husband, Peter, over 30 times since 1972. And I will again in 2008. The same apartment she wrote from in 1948.

A little girl accompanied by her mother came to my C-54 being unloaded on the tarmac at Tempelhof. She brought me her only surviving possession; a well-worn teddy bear. She offered it to me with deep emotion, "This kept me safe during the bombings. I want you to have it to keep you and the other fliers safe on your trips to Berlin." I tried to refuse it but her mother said words to the effect that I must accept it because her daughter wanted to do all in her power to help save their city. I would like to find that little

girl.

In 1998 on a visit to Berlin flying an old Airlift C-54, The Spirit of Freedom, with Tim Chopp, a 60 year old man told me he had caught a parachute in 1948 with a fresh Hershey candy bar. "It took me a week to eat it. I hid it day and night. But the chocolate was not the most important thing. The most important thing was that someone in America knew I was in trouble and someone cared. That meant hope." With moist eyes he said, "Without hope the soul dies. I can live on thin rations, but not without hope." Hope is what the British, French and American Airlift, its flour, dried eggs, dried potatoes, dried milk and coal meant to the Berliners, hope for freedom. Everyone needs hope today as much as the West Berliners needed it then. Hope is a universal need. Transport aircraft, and the airlift they provide, deliver hope to the unfortunate around the world who are oppressed by man or nature.

My experience on the Airlift taught me that gratitude, hope, and service before self can bring happiness to the soul when the opposite brings despair. Because not one of 30 children begged for chocolate, thousands of children in Berlin received over 20 tons of chocolate, gum and other goodies, delivered on the ground, or dropped from C-54 Skymaster aircraft over a 14 month period. It all came from other aircraft and other crews in addition to myself.

In my view General Clay was the man for the hour. General Tunner, in particular, made the Berlin Airlift work. He was an Airlift genius. Of the rank and file military it was not the pilots who were the greatest in my view. It was the aircraft mechanics who changed engines in the middle of the night out

in the open field, with but a canvas to protect them, day or night, freezing rain or snow. There would have been no aircraft over Berlin but for their efforts. Without the Ground Control Radar operators there would not have been as many planes on the ground in Berlin during much of the Lift, especially in November 1948.

There were thirty one true American heroes of the Airlift. I was not one of these. These are they who gave their lives for the Freedom of their former enemies, the Germans, who had become friends. There were 39 of my British comrades who did the same. The Berlin Airlift changed post war history and the rest of my life.

Gail S. Halvorsen Col USAF (Ret)
<http://wigglywings.weebly.com/the-candy-bomber.html>

Other links to activities and material on the Candy Bomber and Operation Little Vittles.

<http://wigglywings.weebly.com/select-documents.html>

http://www.charlesbridge.com/client/client_pdfs/downloadables/CandyBomber_ActivityDiscussion_Guide.pdf

<http://www.raisingmemories.com/2013/11/christmas-from-heaven-how-to-make-candy.html>

http://wigglywings.weebly.com/uploads/2/1/1/2/21122262/parachutes_candy_and_uncle_wiggly_wings.pdf

DEN MEETINGS



Resourcefulness Ideas

http://www.ehow.com/list_7475228_activities-describe-resourcefulness-children.html

The "Invention Convention" theme from 2005 has some great ideas for resourcefulness:

<http://usscouts.org/usscouts/bbugle/bb0502.pdf>



TIGERS

Wendy, Chief Seattle Council

Meeting #13

- DO:**
- E. #26, Practice making phone calls
 - E. #27, Dealing with emergencies
 - E. #12, Make two cards or decorations for a long term care facility
 - E. #15, Mix primary colors to make secondary colors

Meeting #14

- DO:**
- E. #43, Veterinarian or animal groomer fieldtrip.
 - E31, Learn about an animal.

Card Ideas



Talking Frog Card:

<http://www.busybeekidscrafts.com/Talking-Frog-Card.html>



Simple Pop-up Card;

<http://www.wikihow.com/Make-a-Pop-Up-Card>

Pet Ideas

For more ideas, see the themes:

'01 "Man's Best Friend"

<http://www.scoutingthenet.com/Training/Roundtable/Handouts/01/02/>

'05 "Cub Pet Pals"

<http://www.scoutingthenet.com/scouting/Training/Roundtable/Handouts/05/04/>

If scoutingthenet doesn't work, use these links:

<http://usscouts.org/bbugle.asp> ,

<http://www.macscouter.com/CubScouts/>

Activities

Virtual Pet Show

Piedmont Council

Instead of having a real pet show, boys bring drawings or photos of their pet. Each boy stands next to his pet's photo and talks about his pet. They can also bring one or two of their pet's favorite toys, food, or maybe a taping of the pet's voice. Those boys who do not have pets may create imaginary ones (pet dinosaur? pet gorilla?) and have a showing with drawings and other paraphernalia.

Pet Rocks:



<http://familycrafts.about.com/od/stoneandrock/ss/petrocks.htm>



<http://crafts.kaboose.com/pet-rocks.html>

Pet Rock Home:

<http://www.wikihow.com/Create-a-Home-for-Your-Pet-Rock>



Caring for your Pet Rock:

<http://www.wikihow.com/Care-for-Your-Pet-Rock>



Cat/Dog "I've Been Fed" sign: :

<http://spoonful.com/crafts/ive-been-fed-cat-sign>



Eggimals:

<http://spoonful.com/crafts/herd-of-eggimals>



Pom Pom Pets:

<http://spoonful.com/crafts/pom-pom-party>

Shrink Art Back Pack Dangles:

Using permanent markers, draw dog bones, paw prints, easy cat & dog faces, fish, etc. on white Styrofoam clam shell take-out containers. Cut out the pictures, and punch holes in the top of the shapes with a hole punch. Bake on foil-lined cookie sheets, at about 275 degrees (or more, if the shapes aren't shrinking), for 3-5 minutes. The shapes will shrink to about ¼ their original size. Using string, attach shapes to a lanyard clip. Add beads if desired.

Pet Treats: make treats for pets, using one of the recipes found in the treat links below.

For more activities, look in:

- ↳ '01 Baloo's Bugle "Man's Best Friend" p. 7-9.
- ↳ '01 Santa Clara "Man's Best Friend" p. 3; 24-28.
- ↳ '05 Baloo's Bugle "Cub Pet Pals" p. 9-12.
- ↳ '05 Santa Clara "Cub Pet Pals" p. 3; 17-19.

Games

Obedience School

Baltimore Area Council

Based on Simon Says, preface the commands with "The Trainer Says" Use appropriate dog tricks or behaviors such as lie down, beg for a treat, roll over, speak (woof), scratch your ear, wag your tail, show your tongue and pant.

Animal Charades

Circle 10 Council

Charades is a great game -- indoors or out -- for toddlers or mixed age groups. Everyone sits in a semi-circle and, one at a time; each child is given the name of an animal to act out (without sound). You can simplify the game by saying -- this is a barnyard animal, an animal from Australia, or the zoo.

For more games, look in:

- ↳ '01 Baloo's Bugle "Man's Best Friend" p. 5-6; 11.
- ↳ '01 Santa Clara "Man's Best Friend" p. 5-6; 18-20.
- ↳ '05 Baloo's Bugle "Cub Pet Pals" p. 7-8; 15-16.
- ↳ '05 Santa Clara "Cub Pet Pals" p. 5-7; 20-23.

Songs (Tiger E6)

Bingo

Baltimore Area Council

There was a farmer, had a dog,
And Bingo was his name-O
B-I-N-G-O, B-I-N-G-O, B-I-N-G-O,
And Bingo was his name-O.

There was a farmer, had a dog,
And Bingo was his name-o.
(Clap)-I-N-G-O, (Clap)-I-N-G-O, (Clap)-I-N-G-O.
And Bingo was his name-O.

(Repeat. Each time replace one more letter of Bingo's name with a clap.)

For more songs, look in:

- ↳ '01 Baloo's Bugle "Man's Best Friend" p. 11-12.
- ↳ '01 Santa Clara "Man's Best Friend" p. 21-23.
- ↳ '05 Baloo's Bugle "Cub Pet Pals" p. 17-18.
- ↳ '05 Santa Clara "Cub Pet Pals" p. 15-16.

Treats

Goldfish crackers & Swedish fish would make good treats.



Animal Track Cup Cakes:

<http://spoonful.com/recipes/cub-cakes>



Puppy Cup Cake:

Use candy and cookies to make puppy face on cup cakes



Cat Cup Cakes:

<http://www.buzzfeed.com/catsparella/25-halloween-cat-cupcakes-1ruv>

For more people & pet treats, look in:

- ✦ '01 Baloo's Bugle "Man's Best Friend" p. 12-13.
- ✦ '01 Santa Clara "Man's Best Friend" p. 29-30.
- ✦ '05 Baloo's Bugle "Cub Pet Pals" p. 12; 18-21.
- ✦ '05 Santa Clara "Cub Pet Pals" p. 23-26.

Tiger Den Meeting #13 – (Colorful world)

Fool the Leprechaun Game

Alice, Golden Empire Council

One boy is chosen to be the leprechaun, and must leave the room while a coin is handed to one of the other players. All the players sit in a circle with the leprechaun standing in the middle.

On signal, the seated players begin passing the coin around the circle, being careful to hide the coin from the leprechaun's view. The coin can reverse direction at any time, and players without the coin can pretend to pass it along to add to the challenge.

When the leprechaun thinks he knows who has the coin, he calls "stop" and names the suspect.

If the leprechaun guesses right, the 2 players switch places. If not, play continues.



WOLF

Wendy, Chief Seattle Council

Wolves are working on Electives #10 American Indians and #14 Pets.

Den Meeting 13: E14 Pets

E14b What to do when meeting a strange dog

E14c Read a book about a pet a talk about it at den meeting

E14d Rabid animals.

Den Meeting 14: E10 American Indians

Pet Ideas

For pet ideas, see the Tiger section above.

American Indian Ideas

Native American Items (Wolf E10d):



Baskets: :

<http://spoonful.com/thanksgiving/thanksgiving-traditions-gallery#carousel-id=photo-carousel&carousel-item=26>



Parfleche: <http://spoonful.com/crafts/coffee-bag-sandwich-wrap>

Decorate the sandwich wrapper with stickers. Not sure how well this would keep the sandwich fresh.

Pictograph Story (Wolf E10f)

from '02 Santa Clara Pow Wow Book

Materials: Brown paper grocery bag, marking pens (assorted colors), yarn, ribbon or string.

Directions: Cut bag at seams. Smooth flat. Create an animal skin by tearing edges of bag. Use word pictures to tell a story. When finished, roll up and tie with yarn or string. Indian drawings are in the Wolf book.

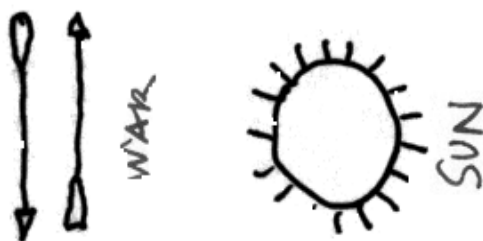
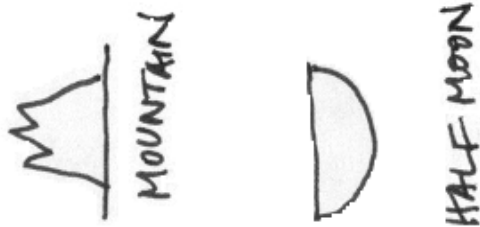
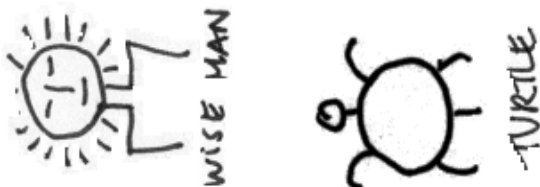
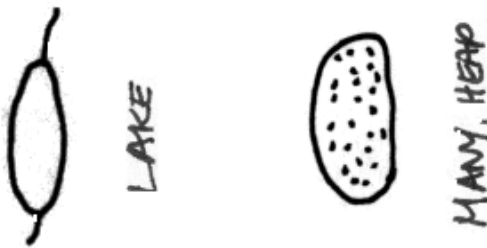
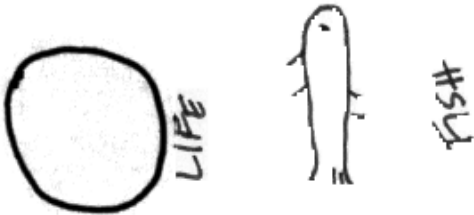
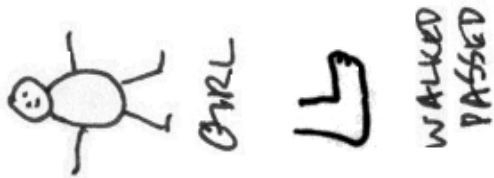

Say "hello" in another language (Wolf E22a): "Hau" or "Yahht-e'eh"(Navajo).

Musical Instruments (Wolf E10b)

Drum: using permanent markers, color or trace a native American design onto a beige heavy duty shower curtain. Cut around the patterns, and duct tape it to a large coffee can or plastic flower pot. Alternatively, you can duct tape a plastic plate to the top of the can or pot. Decorate the sides of the drum with paint or more duct tape.



Drum: using permanent markers, color or trace a native American design onto a beige heavy duty shower curtain. Cut around the patterns, and duct tape it to a large coffee can or plastic flower pot. Alternatively, you can duct tape a plastic plate to the top of the can or pot. Decorate the sides of the drum with paint or more duct tape.



Rattle: Cub Scout How To Book, p. 5-42. If you use tree branches and brown craft paper for the paper mache, the rattle looks like it has been made from an animal hide, and looks quite authentic. You can find rolls of craft paper in the painting aisle of the home improvement store.



Rainstick: '6-'7 Program Helps, March p. 6. or the Cardinal District Round Table Handout:

<http://www.cardinaldistrict.net/docs/cubrthandout200702.pdf>

You can use the pictograph story from above to wrap around your rain stick.

Materials: Cardboard tube (wrapping paper tube or mailing tube), aluminum foil, unpopped popcorn or dry rice, brown paper (grocery bag), glue, scissors, crayons or markers, construction paper.

Directions: Cut a piece of construction paper to fit around the tube. Glue paper to the tube, holding in place with rubber bands until dry. Trace around the end of the tube onto a piece of brown paper (or construction paper). Draw a bigger circle around that circle and then draw a lot of spokes between the two circles. Cut along the spokes, Put glue on the spokes and glue the cap onto one end of your tube. (I spread glue around the tube ends, and then scrunched the paper caps over them. I used a rubber band on one end, and wrapped hemp around the other end.) Cut a piece of aluminum foil that is about one and one-half times the length of your tube and about 6 in. wide. Crunch the aluminum foil into a long, thin, snakelike

shape. Then twist the foil into a spring shape. Put the aluminum foil spring into your tube. Pour ¼ C. rice or popcorn into your tube. Make another cap from brown paper and cap your tube. Decorate as desired. Turn rain sticks up and down slowly and listen to the sound of rain.

Notes: I spread glue around the tube ends, and then scrunched the paper caps over them. I used a rubber band on one end, and wrapped hemp around the other end. The smaller the grains put into the rain sticks, the softer the sound. I like to use cous-cous. – W.M.



Marshmallow Blow Guns

Cherokee, Central American, South American, and Amazon Indians use blow guns, also called a blow tube or blow pipe. Traditional blow pipes are 3-6 feet long. They use round seeds, clay pellets, or darts as ammunition. Sometimes the darts are poisoned. The blow guns are used to hunt small animals, such as monkeys or rabbits.

Cut 1" PVC pipe into 1 foot pieces. If necessary, use a table knife to scrape the fuzzy edges off the PVC pieces. Decorate the pipes using permanent markers, yarn, feathers, and beads..



Marshmallow Darts

Lay a toothpick at the end of the masking tape, with the top of the toothpick level with the edge of the masking tape. Move the toothpick over ½ inch onto the tape, so the tape sticks to itself and creates a fin. Position the tape so it goes past the toothpick about ½ inch. Fold the tape over on itself to make another ½ inch fin. Cut the tape, and repeat a third time to make a third fin. Make sure the fins are small enough that the darts will fit in the blow gun. Push the toothpick into a mini marshmallow. The boys will notice that the darts fly differently, depending on how they are loaded into the blow gun. This is because the fins are probably not the same size.

Clay Pot: How To Book p. 2-22.

Games:

Rattlesnake Tag

from '02 Santa Clara Pow Wow Book

This is played by Plains, Woodland, Northwest Coastal and Southwest tribes. Since rattlesnakes are found throughout the Americas, this game was developed in many forms by numerous tribes.

Arrange Cub Scouts in a circle about 20 feet in diameter. Blindfold two contestants, the snake and the hunter. Give the rattler a tin can containing some pebbles or a maraca, and stand the two players on opposite sides of the circle. At given intervals, about 15 seconds apart, the group hisses; the rattler responds by shaking his rattle at each hiss. The hunter tries to

touch the snake; after his happens, select a new rattler and hunter.

IMPORTANT safety precaution. Since the players are both blindfolded, they need to move slowly and carefully, listening to each other. If the chief (you) shouts 'STOP,' all players MUST freeze.

Ball Race (Wolf E4f): Played by Southwestern tribes. Each team gets a can (paint a stripe on one so the teams can tell which can is theirs). Each team gets a goal (a blanket on the floor). Like soccer, the object is to kick your can into the goal. Play with both cans at the same time. *Note: you might want to wrap the cans in corrugated cardboard to increase safety.*

Run & Yell: Salish-Kootenai game. Boys take a deep breath, then yell and run. They run as far as they can while yelling. When they need to take a breath, they must stop. The boy that runs the farthest wins.

American Indian House Treats (Wolf E10e)



Edible Tepee: <http://spoonful.com/crafts/tepee-treats>

Edible Igloo

Trapper Trails Council

Ingredients:

1/2 apple, cored; miniature marshmallows; peanut butter

Directions

1. Place apple cut side down on a plate
2. Spread with peanut butter, cream cheese, or frosting all over the outside of the apple
3. Cover peanut butter with the miniature marshmallows
4. Add a tunnel entrance by slicing a banana in half the long way, and then cutting it into 1" – 2" chunks. Place the half-cylinder banana piece by the apple. Cover with peanut butter and marshmallows.

For more Native American ideas, see these themes:

2002 "Native Peoples"

<http://www.scoutingthenet.com/Training/Roundtable/Handouts/02/01/>

2007 "Indian Nations"

<http://www.scoutingthenet.com/scouting/Training/Roundtable/Handouts/07/10/>

Wolf Den Meeting #12

Alice, Golden Empire Council

Arrange to visit the library and have the librarian show how to find books, videos, CDs or other items about Compassion. To celebrate **Dr. Seuss' Birthday & Read Across America Day** you can read "Horton Hears a Who" – it's a book that teaches compassion by example in a really fun way!



BEAR



Core Value - Compassion

Bear Achievements:

Mtg Plan #: D Build a Model (rockets) Achievement 21f & g

Mtg #: O See a Model Achievement 21e

Mtg #: P Family Fun Achievement 10a

Den Plan D Build a model Achievement 21 f & g



Here is an Alka-seltzer rocket

<http://spaceplace.nasa.gov/pop-rocket/>

<http://www.popsci.com/diy/article/2013-01/build-and-launch-mini-rocket>

MATERIALS

- Paper
- Pencil

- Scissors
- Glue
- Effervescent Antacid tablet (such as Alka-Seltzer)
- Water
- Empty canister (also works w/ M&M mini tubes ☺)



1 Design your rocket out of paper & glue them together. You will need a cylinder, a nose cone, & a pair of fins. It should stand around 6" (15 cm) tall & be approximately 1½" (3.75 cm) in diameter (you may want to play w/ the sizes to fit the mini tubes or canister's you find).

2 Open & drop 1/2 of an Alka-Seltzer tablet into the canister.

3 Fill the canister 1/3 of the way full of water & snap the cap closed. **HOLD the Bottom on** while you: Slide the rocket over the canister, place the assembly cap-down, & get back. Watch the rocket blast off.

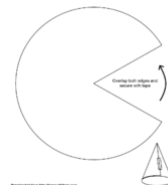

pattern for rocket fins & cone.



Bendy Straw Rocket

<http://dollarstorecrafts.com/2011/07/man-crafts-bendy-straw-and-paper-rockets/>

Using paper cut-outs, toothpicks & bendy straws you can make your own flying rockets!

- computer printer + paper
- scissors
- bendy straw
- thread
- toothpick
- adhesive tape

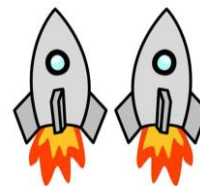

1. Pick a picture of a rocket – make 3" paper rockets – you will need 2 one for the front & one for the back of your rocket.

2. Cut different lengths, 4" (10cm) or less, of red, yellow & orange thread to be the rocket exhaust.
3. Put the threads & the toothpick between the 2 rockets. The threads & toothpick go toward the bottom end of the rocket, with the toothpick 2/3 exposed.
4. Tape or hot glue to secure everything in place.

Place the toothpick end in the short end of the bendy straw, take a deep breath & blow into the long end of the straw. The rocket will fly out.

Free cartoon rocket images to use for the bendy straw rocket can be found here.

http://www.123rf.com/stock-photo/cartoon_rocket.html

Research Rocket Building. See the *Cub Scout Leader How-To Book* No. 33832 (*this is not in the current publication*), www.scoutingmagazine.org/issues/0611/a-redy.html (for an article on Water Rockets) and <http://wwong.homestead.com/rockets.html> a wonderful website by Wesley Wong of the Pioneer District. The following rockets are just a small sample of the great things on this site & in the POW WOW 2007 - Fun with Rockets! Manual you can access there. If your pack wants to run a rocket derby – everything you need to know can be found there.

Use your paper rocket to play a **Planet**

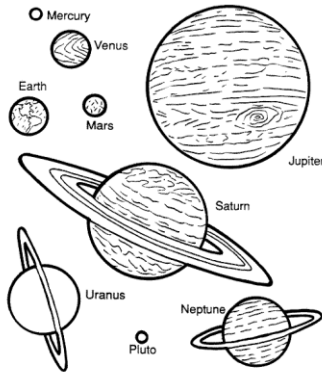

Free Coloring pages of each individual planet can be found here:

http://www.windows2universe.org/coloring_book/index_beg_edu.html

<http://www.enchantedlearning.com/subjects/astronomy/activities/coloring/>

Game

Make a sun out of yellow paper. Write the planet names and point values onto paper planets. The farther away a planet is from the sun, the more points it should have. If you have the room to make orbital rings you can make these out of string, twine, or even curling ribbon. (*If you plan to play outside – you may want to draw you solar system with sidewalk chalk – so it wont blow away*). Place your sun on the floor, then 1 foot away from your sun put your Mercury, 2 feet from your sun - Venus, 3 feet from your sun - Earth, 4" Mars, 5' Jupitar, 6' Saturn, 7' uranus, 8' Neptune, & 9' Pluto. Use your homemade rockets to aim for the targets.

Download or listen to a free educational **song**

ZOOMING ROCKET. <http://www.kidsknowit.com/educational-songs/play-educational-song.php?song=Zooming%20Rocket>



Sausage & colored pepper rocket

<http://www.annabelkarmel.com/recipes/party-food/sausage-rockets>

Jokes:

Why was the rocket hot in anger?

He got fired!

What did the astronaut get when the rocket fell on his foot?

Mistletoe.

What do astronauts do when they get angry?

Blast off!

Why couldn't the astronaut book a room on the moon?

Because it was full.

How do astronauts serve dinner?

On flying saucers

<http://www.sciencekids.co.nz/jokes/space.html>

Den Plan O See a model Achievement 21 e

If you don't know of any, ask around. In my town there is a historic theater building that has been converted into shops. Inside they have a model of the theater in its original condition. Some museums, historical associations, or other organizations may have a model you can take the boys to see.



Make a **model train you can eat** (*no baking required*) See the following site for the directions.

<http://www.annabelkarmel.com/recipes/party-food/kid-birthday-cake-train>

Den Plan P Family Fun Achievement 10**Achievement 10a.**

Visit a park, museum, airport, seashore, farm or ranch, performance, go bowling, etc

Achievement 10b

Make a game to play with your family.

**Make a sandwich game**

1. = Bread
2. = Mustard
3. = Cheese
4. = Pickles (or other topping of choice)
5. = Lettuce (or other topping of choice)
6. = Tomato (or other topping of choice)

Once all your sandwich pieces are cut you can play the game! This game is played like 'Cootie'. The object of the game is to roll the die and create a sandwich. Everyone starts with nothing. All players take turns rolling the die, when someone rolls a 1 they get to take a piece of bread. Once a person has their bread, they then need to roll a 2 and put the mustard on the bread. For the toppings: the numbers and parts can be acquired in any order. When a player has 1 of each topping he must roll a 1 to finish with a slice of bread. The first person to finish making a sandwich with all the toppings and 2 slices of bread wins the game!

NOTE: For your pieces, you could use colored paper, magazine pictures, felt, scrap material, wallpaper samples, etc....

Another way to play is to make a pizza see the following for directions:

<http://familycrafts.about.com/cs/homemadegames/a/blpizgame.htm>

Here is a **site** with some neat **games to make:**

<http://craftyjournal.com/homemade-kid-games/>

WEBELOS DENS

Joe Trovato

WEBELOS RT Break Out Coordinator
Manitoga District
Westchester-Putnam Council
Have a question or comment for Joe??

Write him at

webelos_willie@yahoo.com

There is an underscore between Webelos and Willie

Core Value for March

Compassion: Being kind and considerate and showing concern for the well-being of others.

“Compassion and Tolerance are not a sign of weakness, but a sign of strength.” – Dali Lama

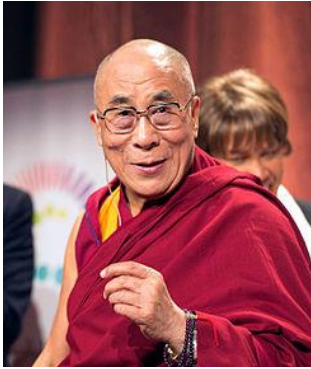

Dalai Lama, Tibet's political and religious leader, has strived to make Tibet an independent and democratic state from China. He and his followers are exiled to India

.For more on the life of the Dali Lama see:
<http://www.biography.com/people/dalai-lama-9264833>

Den activities that help your Webelos Scouts learn about and practice compassion should routinely be made part of advancement activities as well as **Friendly Service** to others.

Remember, Friendly Service is one of the ten Purposes of Cub Scouting!

Service Demonstrating Compassion

www.pointsoflight.com

C. Murphy



Volunteering as a family while kids are young develops a positive service habit that sticks long into adulthood. Use the

following four tips to help ensure your kids understand the impact of their good deeds

- Donate gently used books and DVDs to a local children’s hospital.
- Engage a team to secretly rake leaves or shovel snow for an elderly neighbor for a whole month.
- Collect used towels and pet toys for the local animal shelter.
- Host a hot chocolate or cider stand and donate the proceeds to a charity.

Celebrate your service!



- If donating goods or money to a local charity, deliver the items with your kids in person so they can better internalize how they helped make a difference.
- Be sure to talk about your family’s service experience. Discuss what you did, why you did it, how it felt, and what you learned.
- Build on your kids’ enthusiasm and *right then* choose your next service project together.

Activities for Exploring Compassion

BrightHorizons.com



To encourage empathy, caring, compassion and social activism in your Webelos you can:

- Discuss feelings and consequences of actions. Children who are helped to understand emotions and how their behavior impacts others are more likely to develop a deeper sense of.

- Don't be afraid to explore negative emotions. Children who are allowed to show anger, sadness, or distress and helped to cope with these emotions tend to become more sympathetic and competent in later social situations.
- Validate caring behavior when you observe it in an effort to help children identify positive courses of action. For example, "I noticed you helped Jimmy when he had trouble with making a square knot. That was a very kind thing to do."
- Provide opportunities for the scout to care for someone or something other than themselves - a pet, a plant, or another person. Even if you can't take in a pet, perhaps you can have your child feed a neighbor's cat. Other ideas are baking cookies for a sick friend, or checking-in regularly on an elderly neighbor.
- Remember that children first have to feel good about themselves to turn those positive feelings towards others. Children who grow up with helping and responsibility modeled are more likely to show those behaviors towards others.

Book Corner

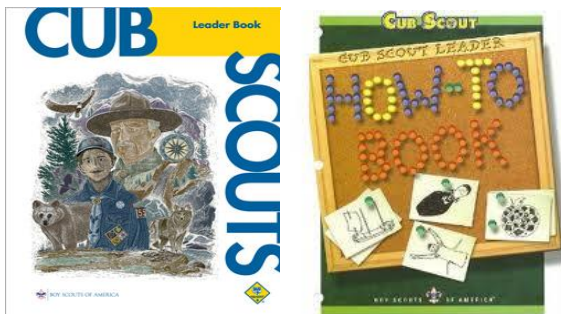

Check out pages 4-3 and 4-6 of the *Cub Scout Leader Book* for more on **compassion**. In addition, don't forget that as a WEBELOS leader, **compassion** plays a role in guiding your scouts to success. See page 15-5 for some suggestions on how a Leader can help his scouts deal with everyday problems and stresses. For more on Service Projects, see page 15-4.

http://www.scouting.org/filestore/hispanic/english/33221_WEB.pdf

The *How-To Book's* discussion of Leader/Scout relationship on pages 1-12 and 1-13, echoes the need for us leaders to be compassionate in our dealing with the Scouts mentioned in the *Cub Scout Leader Book*. As role models, the scouts will emulate our leadership in their dealings with others.

http://www.scouting.org/filestore/hispanic/english/33832_WEB.pdf

Meeting Planner

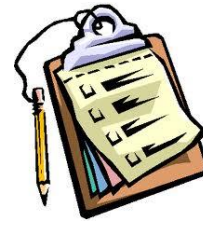

This month's meeting plans for **First year Webelos** work on the Craftsman badge and do some work at home on Scholar and Artist.

Meeting 13: Craftsman. Do: Craftsman 1, 2

HA: Review Craftsman, Scholar, and Artist chapters.

<http://www.scouting.org/filestore/CubScoutMeetingGuide/webelos/WebelosMeeting13.pdf>

Meeting 14: Craftsman. Do: Craftsman 3, 4

HA: Scholar 11. Review Scholar and Artist chapters

<http://www.scouting.org/filestore/CubScoutMeetingGuide/webelos/WebelosMeeting14.pdf>

In March, **Second year Webelos (Arrow of Light)** work on Communicator and Sportsman.

Meeting 13: Communicator. Verify: Communicator 11-14 (or alternatives)

Do: Communicator 3, 4, 6

HA: Review Sportsman chapter.

<http://www.scouting.org/filestore/CubScoutMeetingGuide/ArrowofLight/ArrowofLightMeeting13.pdf>

Meeting 14: Sportsman. Do: Bicycle belt loop

<http://www.scouting.org/filestore/CubScoutMeetingGuide/ArrowofLight/ArrowofLightMeeting14.pdf>

Flag Ceremony



You should ensure that a formal flag ceremony be performed at your den meeting and at the monthly Pack meeting. Do it on a rotation basis to satisfy Webelos requirement 6. I like adding something that is “month appropriate” to the basic ceremony. For example March is both Woman’s History Month and National Nutrition Month. See the March 2011 edition of Baloo’s Bugle for a Woman’s History Month Flag ceremony and the March 2013 edition for a ceremony on nutrition.

Template for Flag Ceremony

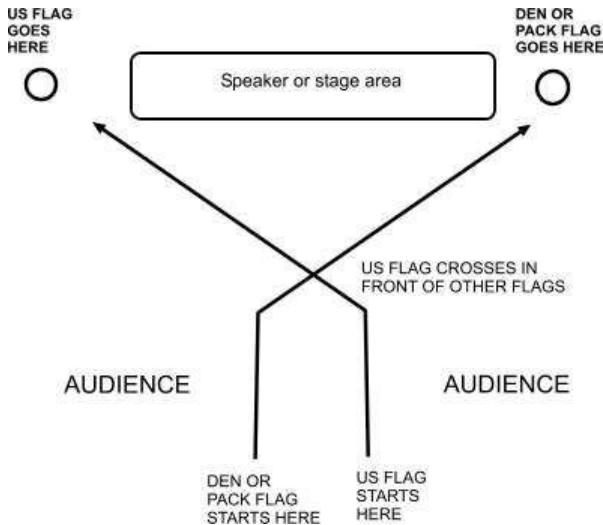

Steps	Announcer	Description
1	“WILL THE AUDIENCE PLEASE RISE?”	
2	“COLOR GUARDS ATTENTION”	Make sure color guards are ready.
3	“COLOR GUARDS ADVANCE”	Flag bearers and color guards walk down aisle and head to respective flag post. Flag bearers hold flags for pledge. Bearers do not salute.
4	“PLEASE JOIN ME IN THE PLEDGE OF ALLEGIANCE—SCOUT	Announcer salutes and <u>begins the Pledge of Allegiance</u> . Flag bearers do not salute.
5	“TWO!”	After Pledge the announcer drops salute upon saying “Two!”
6	“POST THE COLORS”	American flag is posted first. Pack flag is posted last. Cub Scouts take a step away from flags after posting.
7	“COLOR GUARDS DISMISSED”	Return to your seats.

Den Meeting Helpers

These activities can be used for the gathering or to reinforce/satisfy badge requirements.

Webelos



Craftsman



This badge will be a favorite, but requires a lot of preparation. Some projects, like leatherwork and cardboard, can be held at your regular meeting place. Others, like woodworking, should be held in a shop or garage where the sawdust can be contained easier. Because every Cub wants to do something, you'll need a large supply of hammers or set up cutting, sanding, nailing, and gluing stations. Have small groups rotate around as the work progresses. If everybody is starting fresh, you may need a second project to keep all boys busy. An adult helper or guide with each group or an adult supervisor at each station is both good methods. Remember, everyone is included in the clean-up.

Craftsman Ideas

- Discuss finishing methods for wood projects – sanding, filling holes and scratches, finishing, etc.
- Have a nail driving contest.
- Make a tool chest or bench horse for sawing.
- Build mid-way games for your pack.
- Visit a building supply store. While there, look at the tools and materials required for different projects.
- Visit a furniture factory, lumber mill, saw mill or cabinetry shop.
- Visit a tanner or leather goods manufacturer.
- Invite someone to give a demonstration on the proper care and use of tools.
- Have a demonstration of leather craft and leather tools
- Blue and Gold centerpieces/decorations are good projects.

What’s in Your Tool Box?

Note: when using tools, adult supervision is required! ONLY adults should handle power tools for safety sake.



Many people use hand tools in their everyday life not just at work. Hand tool safety is important for everyone. Hand tools are: screwdrivers, hammers, chisels, wrenches, shears and knives. These tools are just as dangerous as power tools if they are used incorrectly.

Tool Safety Tips

1. Never use a tool for anything other than its intended job.
2. Always clean your tools after each use. If they get dirty or rusty they will no longer work correctly.
3. Don't carry tools that are sharp such as scissors and pliers in your pocket unless they are in a cover.
4. Transport all tools in a toolbox. Keep them in there when they are not in use.
5. Check the blade on your hand saw before each use. If the blade is dull or cracked do not use it.
6. When cutting anything always cut away from your body.

If you follow **hand tool safety** rules you should remain safe and free of injuries. Also, make sure to check the *Guide to Safe Scouting*, including [Age Appropriate Activities](#) to determine tools that a Webelos Scout may use.

You can find the *Guide to Safe Scouting* on-line at <http://www.scouting.org/scoutsource/HealthandSafety/GSS/toc.aspx>

Cub Scout Flag Stand

Kaboose.com



What you'll need:

1. 1 - standard wooden broom stick
2. 1 - 12" long 1 1/4" PVC pipe
3. 4 - 8" 2x4
4. 8 - 2.5" deck screws
5. Liquid Nails
6. String/twine
7. Flag
8. White spray paint (optional)
9. Blue and Gold craft paint (optional)

How to make it:

1. Cut any piece of 2x4 lumber into four 8" lengths.
2. Do a light sanding to knock off all the big splinters.
3. Using 2 deck screws per 2x4, screw them together leaving just enough room to tightly fit the PVC pipe into the square opening in the middle.
4. It is key that you secure the base together making a flat bottom. Your lumber might be warped a little you have to play with it a little to make the base level.
5. Secure the PVC to the wood using liquid nails.
6. No need to put a screw through the actual PVC, plus I think it's more stable to allow the pole to slide freely through the PVC.
7. Let it dry overnight to make sure the liquid nails were completely cured.
8. Use a 1/4" or so drill bit to put one hole in the broom stick.
9. Spray painted the PVC white. It took several coats.
10. Paint the wood blue and gold.

MAKE A PINEWOOD DERBY CAR DISPLAY*By David Brooks**From the September 2011 issue of Boys' Life magazine***What You'll Need**

- Tape measure
- Ruler
- Saw
- Lumpy rock
- Screwdriver
- Wood screws
- Hammer
- Narrow chisel
- Scissors
- Utility Knife (Optional)
- Wood glue
- 3/4" x 10" x 10 1/2" board
- 3/4" x 3 1/2" x 10 1/2" board
- 12" x 12" cork board
- 1/2" x 2" x 9" wood strip (optional)
- 1/2" x 1" x 9" wood strip (optional)
- Some black paint and white paint
- Paint brush

What You'll Do

1. With the help of an adult, cut out the two boards and whack the small board with a rock. This will make the board rough like asphalt.
2. Chisel out four shallow depressions for the car's wheels to sit in.
3. Glue and screw the two boards together using the three screws. Paint the whole thing black, or any color you like.

4. Use scissors to carefully cut the cork board into 1 1/2" squares. Or, with an adult's help, you can cut the cork with a utility knife.

5. Paint half the corkboard squares black and the other half white.

6. Glue the cork squares to the back of the display.

7. You can place or pin whatever you want on the completed stand. Display it on a flat surface or hang it on the wall.

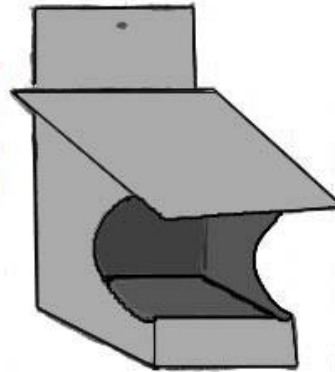
SIMPLE BIRDFEEDER*Santa Clara Council***What You'll Need:**

Wood cut to the dimensions shown below, wood glue, finishing nails or wood screws.

- 1 Back 16" x 10"
- 1 Front 2" x 10"
- 1 Roof 12" x 12"
- 2 Sides 12" x 10"
- 1 Bottom 10" x 10"

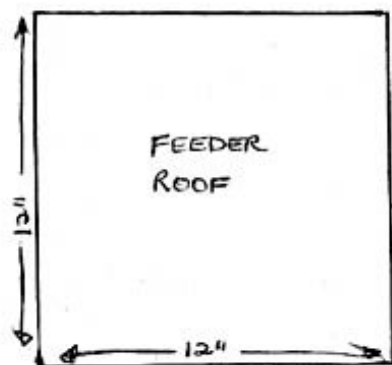
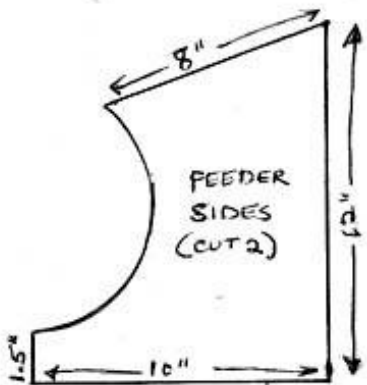
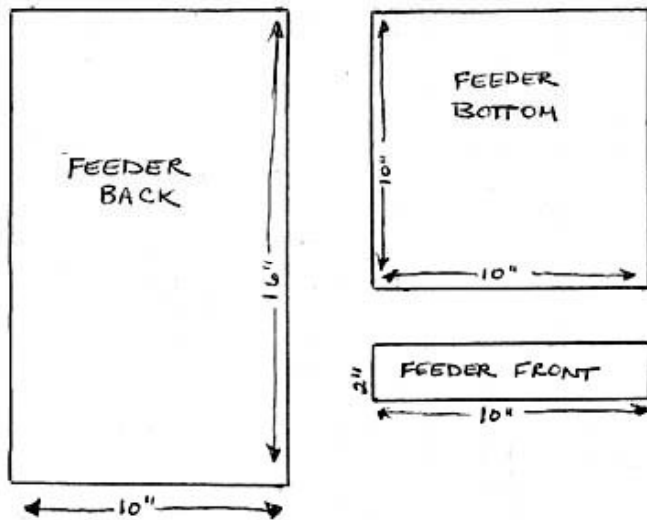

What You'll Do:

1. Cut the wood to the dimensions in the drawings. You can have the lumber yard cut the pieces if you want.
2. For the feeder sides, just make sure the back height is 12" and the bottom length is 10". Measure up 1.5" for the bottom front. From the top back corner, measure down 8" with about a 70 degree angle. This is NOT an exact angle, just

get it approximately 70 degrees. This will slope the roof. Find something round and use it to trace around from the end of the 8" to the top of the 1.5" at the front.

3. Attach the back to the bottom of the feeder, using wood glue and either wood screws or nails.
4. Attach the sides to the bottom and back pieces, using wood glue and either wood screws or nails.
5. Attach the front to the sides and bottom pieces, using wood glue and either wood screws or nails.
6. Attach the roof to the back and side pieces, using wood glue and either wood screws or nails. You may miter the back of the roof piece to make it fit flush against the back. If you do not miter the back of the roof piece, use silicone caulk to keep the rain from dripping into the feeder.
7. Drill a hole in the center of the back, near the top.
8. Stain, paint or put a finish on the outside of the feeder if desired
9. Hang your feeder and fill it with food.

Blue and Gold Decoration

www.makingfriends.com



You Need:

- Scout Friend (Copy and expand the cutout, below)
- Computer
- Printer
- Cardstock paper
- Scissors
- Glue
- 2 Identical pictures of each child (check size!)
- Markers, crayons, or colored pencils

- Tons of Craft Sticks (you'll need more than you think!)
- Low Temp Glue Gun

Instructions:

Print a sheet of Scout Friends on cardstock. Cut out and color one uniform in cub scout colors and one in boy scout colors. Note: The Cub Scout Friend has the diamond shaped rank badges on the pocket. Cut two pieces of cardstock about 1" x 1½". This will become the stand.

Lay one Scout face down on the table. Cover with a layer of glue. Take the piece of cardstock and fold in half to 1" x ¾". Unfold. Place the cardstock at the feet of the friend with the fold facing up and at the bottom of the feet. Put some glue on the part of the card that is above the fold. Place one craft stick down the middle of the Scout Friend. Be sure that the stick will stick up above the neck so that the face can be glued on. Put glue on the back of the stick. Place another *stand* on top of the Popsicle stick, lining it up with the stand below. This time the fold goes down. Put some glue on the part of the card that is above the fold. Place the other Scout Friend face up, lining up with the first Scout Friend. Press together. Let dry. Break a craft stick to fit on the bottom of the stand. Glue in place. This gives the Scout Friend the ability to stand through the whole ceremony. (grin). Cut out the face of the child in the pictures. Glue a face to each side of the Scout Friend. Glue on the hat.

Make your crossover bridge. Anything goes here just dig in and create.

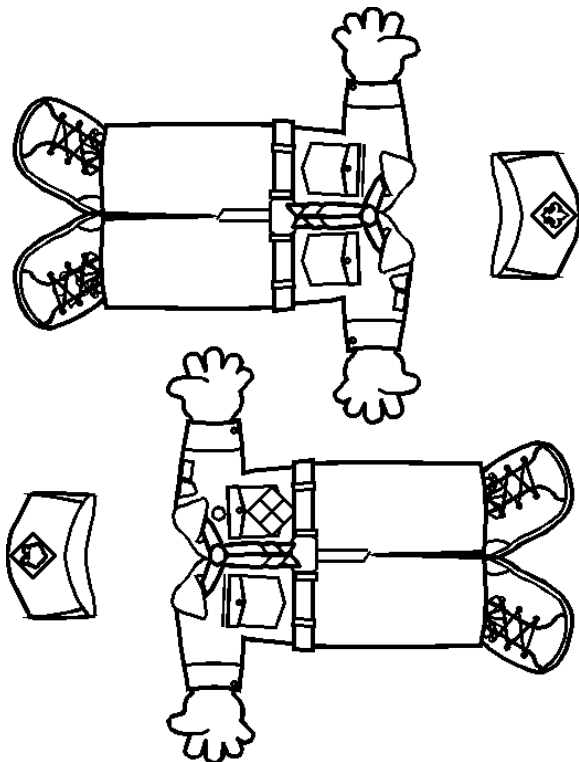

BOOK RACK

Santa Clara Council

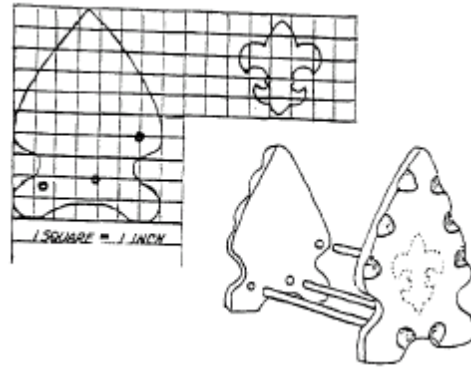

Keeping your Scouting books and other books that you are reading, in this rack will help you find just the book you want quickly.

It also helps to keep your room in order. Making this book rack is not difficult and is a good woodworking project. The end boards of the rack are cut out in the shape of a huge Indian arrowhead. See template for pattern. These are cut from one-half inch hardwood.

Sandpaper the edges off smooth and “chip” the edges with a hall-round file. The chip grooves are made on the outside of the end boards only. The inside surface is left smooth. Three, one-half inch dowels are used for the spreaders. They are 12 inches long, and the ends are glued into holes made in the end boards. These holes must stop short of going through. The proper location of these holes can be determined from the pattern. When boring the holes, be sure to make the ends right hand and left hand. Otherwise, you will be in trouble.

A thin piece of plywood about 1/8 inch thick is used for the Scout emblem. Make one for each end and glue them in place as indicated in the illustration. The rack can be finished any way you desire. It can be stained and lacquered, or finished natural. If you like bright colors, it can be painted with enamel. The emblem should be a contrasting color.

Arrow of Light



Communicator



Communicator Ideas

- At a school or church function, create and post directional signs.
- Read to a visually impaired person.
- Speakers: News broadcaster, radio DJ, politician, minister
- Visit library - talk to librarian, learn how books are indexed.
- Visit radio station - see how it operates.
- Visit television station
- Visit police station or 911 dispatcher - learn how 911 calls are processed and prioritized.
- Visit school for the deaf and/or blind.
- Use a computer to talk to other people.
- Visit a newspaper office - see how a newspaper is put together. Watch the printing presses run.

PANTOMIMES

A fun way to start this activity is to have the Webelos Scouts stand in a circle. The leader makes an action, and the players exaggerate their version. Here are some suggestions to start with...then make up your own and have fun!

- -Say with your hand, "Stop."
- -Say with your head, "Stop."
- -Say with your shoulder, "I bumped the door."
- -Say with your foot, "I'm waiting."

- -Say with your ear, "I hear something."
- -Say with your waist, "I'm dancing."
- -Say with your jaw, "I'm surprised!"
- -Say with your tongue, "Yum, this tastes good."
- -Say with your finger, "Come here!"
- -Say with your fingers, "This is hot!"
- -Say with your nose, "I smell fresh pie."

BODY LANGUAGE

- To play this game, give your den members a piece of paper and a pencil.
- Ask them to think about feelings they can show by body language only - without making a sound.
- Have them make a list of at least five feelings they can show.
- Den members take turns showing one of their feelings. The others try to guess what the feelings are.
- The den leader or den chief can be referee and decide whether the body language really shows the feeling.
- If a den member guesses correctly, he gets one point.
- If nobody guesses correctly, the boy who performed the body language gets one point.
- The final winner is the boy with the most points.

"HEAR, HEAR!" GAME



This is a game identifying sounds. The Webelos den leader or den chief produces sounds from behind a screen while the Webelos Scouts listen. As each sound is produced, tell the boys to write down what sounds they heard. Have the boys write their guesses as specific as possible. Examples of sounds are:

- Sandpaper rubbed on wood
- Deck of cards being shuffled
- Manual egg beater in water
- Golf ball bouncing on wood floor
- Cutting into an apple
- Removing groceries from plastic bag
- Opening an envelope
- Opening a can of soda
- Harmonica
- Adding machine

Vary the objects, sounds, and duration of the sound. Boys may also be blindfolded instead.

Referee Signals

Santa Clara County Council

Referees communicate to the audience and players through hand signals! Here are some that basketball referees use.

BASKETBALL

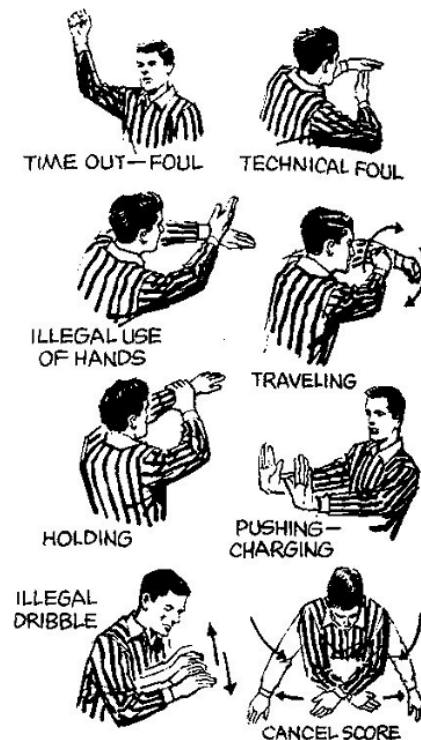

SPORTSMAN



Sportsman Ideas



- Have combined parent/son ball games or tournaments like golf, table tennis, bowling or volleyball.

- Learn sports etiquette along with the normal playing rules of all games.
- Use the Cub Scout Sports program...belt loops and pins.
- Visit a bowling alley and bowl a few games.
- Go ice or roller skating.
- Play a round of miniature golf.
- Invite a referee or coach and have them talk about being a Sportsman.

See last month's Baloo's Bugle for more Sportsman Ideas and Activities

GAMES

A real sportsman follows these rules in each game, but also in his life. Good sportsmanship is part of good Citizenship. For example, losing class election gracefully. The "Spirit of Good Sportsmanship" means being modest in victory as well as accepting defeat gracefully after trying your best.

Balloon Volleyball

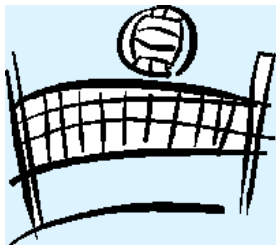

You will need

- 1 - large inflated balloon and
- 1 - long piece of string.

Divide boys into two teams

Seat them on the ground in volleyball positions.

The net is the string fastened between two trees, poles or attached to the walls for indoor use.

The balloon is put into play by a serve

Normal volleyball rules apply, except that the players cannot move from their seated positions on the floor or ground.

Marble Golf



- Set up this game and practice playing it for a future den or pack marbles tournament.
- For holes, bury baby food cans to the brim in the earth.
- Flags are paper triangles glued to craft sticks.
- Add water hazards and sand traps as you wish.
- Shots are taken in the approved knuckles down way for regular marbles.
- Winner is the Webelos who takes the fewest shots to get all the way around.

Ultimate in 10 Simple Rules



This game will take time to learn, but once the rules are picked up, the boys will love it. You will need to use a school field or a large yard. You can reduce the size of the field if space is limited.

The Field

: A rectangular shape with end zones at each end. A regulation field is 70 yards by 40 yards, with end zones 25 yards deep.

Initiate Play

: Each point begins with both teams lining up on the front of their respective end zone line. The defense throws ("pulls") the disc to the offense. A regulation game has seven players per team.

Scoring

: Each time the offense completes a pass in the defense's end zone, the offense scores a point. Play is initiated after each score.

Movement of the Disc

: The disc may be advanced in any direction by completing a pass to a teammate. Players may not run with the disc. The person with the disc ("thrower") has ten seconds to throw the disc. The defender guarding the thrower ("marker") counts out the stall count.

Change of Possession

: When a pass is not completed (e.g. out of bounds, drop, block, interception), the defense immediately takes possession of the disc and becomes the offense.

Substitutions

: Players not in the game may replace players in the game after a score and during an injury timeout.

Non-contact

: No physical contact is allowed between players. Picks and screens are also prohibited. A foul occurs when contact is made.

Fouls

: When a player initiates contact on another player a foul occurs. When a foul disrupts possession, the play resumes as if the possession was retained. If the player committing the foul disagrees with the foul call, the play is redone.

Self-Officiating

: Players are responsible for their own foul and line calls. Players resolve their own disputes.

Spirit of the Game

: Ultimate stresses sportsmanship and fair play. Competitive play is encouraged, but never at the expense of respect between players, adherence to the rules, and the basic joy of play.

From the Academics and Sports Program Guide

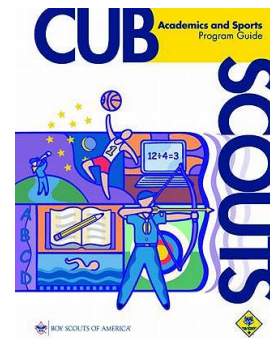
**Bicycling Belt Loop****Complete these three requirements:**

- _____ 1. Explain the rules of safe bicycling to your den leader or adult partner.
- _____ 2. Demonstrate how to wear the proper safety equipment for bicycling.
- _____ 3. Show how to ride a bike safely. Ride for at least half an hour with an adult partner, family, or den.

**Bicycling Sports Pin****Earn the Bicycling belt loop, complete requirement 1 below, and do four additional requirements:**

- _____ 1. Make a chart to record at least 10 hours of bicycling. (Required)
- _____ 2. Participate in a pack, den, or community bike rodeo.
- _____ 3. Demonstrate how to repair a flat tire on a bicycle.
- _____ 4. Make a poster illustrating different types of early bikes and show it to your den.
- _____ 5. Give a demonstration to your den or pack on the proper use of safety equipment and gear.
- _____ 6. With the help of a parent or adult partner, register or reregister your bicycle.
- _____ 7. Go on a "bicycle hike" with your family or den. Obey traffic rules related to bicycling.
- _____ 8. Repair or restore a nonfunctioning bicycle to

a safe condition. Include the installation of all proper safety devices.

_____ 9. Visit a bicycle race or exhibition.

_____ 10. Help set up a bike rodeo or bike competition for your pack.

Some Riding Safety Tips

- Be equipped properly (including reflectors!). Always wear a helmet.
- Obey traffic signs and signals.
- Never ride against traffic.
- Follow lane markings.
- Use hand signals.
- Choose the best way to turn left: signaling and turning from the left lane, or riding to the far-side crosswalk and walking your bike across the street.
- Ride in a straight line.
- Don't pass on the right.
- Don't weave between parked cars or cars stopped in traffic.
- Ride slowly on sidewalks.
- Keep your bike in good repair.
- Watch for cars pulling out in front of you.
- Scan the road behind you (you might want to have a rearview mirror).
- Use lights at night.
- Avoid road hazards.
- Dress appropriately.
- Know how to stop suddenly.
- Use a pack or rack to carry things.

Bike Quick Check

Utah Department of Health



A - is for Air

- Make sure tire is properly inflated
- Check tire sidewall and tread for cracks

B - is for Brakes

- Check pads for wear, replace if there is less than ¼ inch of pad left

- Make sure pads don't rub on the tire or into spokes
- Pull the brake lever, there should be at least 1 inch between the handlebar and the brake lever when fully applied

C - is for Cranks, Chain and Cassette (gears)

- Make sure cranks are tight
- Check the chain for wear (12 links should measure no more than 12 1/8 inches)
- Check your gears for broken teeth
- Make sure your chain is lubricated

Quick - is for Quick Release

- Make sure that wheels are tight and secure in the bicycle frame
- Make sure Quick Release Levers are closed (or wheel bolts are tight)

Check - is for Check it Over

- Before beginning your ride, take the bike for a quick little spin to make sure it is working properly

Hand Signals

Unlike a motor vehicle, a bicycle does not come with turn signals or brake lights. However, it is still important for the bicyclist to tell other road users what he/she intends to do. A bicyclist uses hand signals to communicate to others on the road what he/she is about to do.

There are hand signals for turning left, right, and slowing down. Below are the hand signals for each.



It is important to practice using the hand signals in an area such as a parking lot so that you can learn to keep control of your bicycle while doing them. If you do not feel comfortable using hand signals when riding on the street with traffic, or you may lose control of your bicycle trying to do a hand signal, then do not use them until you have practiced the skill and are able to do it without losing control of your bicycle. It is more important for you to be safe.

Bike Rodeo Events

By David Fiedler, About.com



Activities for Kids to Develop Riding Skills, Bike Handling Ability

Below are ten different events and activities you can use as part of a bike rodeo. Each of these can be a particular station that each kid must complete in order to successfully "pass" the bike rodeo and be eligible for any prizes that you might choose to offer. In general, each station is worth ten points, and points are awarded or deducted for performance of each. Keep track of each kid's score and tally them at the end if you wish to award prizes to the top performers. Note that most of these events can be scaled up or down to fit the space you have available.

1. **Safety Check:** Check that each kid's bike is road-worthy by inspecting tires, brakes, handlebars and chain. Below is a detailed guide of what to look for at the Bicycle Inspection Station.
2. **Helmet Inspection:** Each kid's helmet should fit snugly, and come mid-way down the forehead. Check to be sure that the chin strap is tight enough and that it fastens properly, and that there are no cracks in the inner shell or outer helmet.
3. **Zig-Zag Course:** Create a course using chalk, tape or paint to create a zig-zag path between 30 and 50 feet long with four or five 90-degree turns along the way. The edges should be about three feet apart. Deduct 1 point each time a kid's wheel touches a side.
4. **Slow Race:** Lay out a course that is either a long straight line or a loop that brings riders back to the start. Two riders at a time should compete, pairing kids of approximate same age and riding ability. The object of this event is to be last, i.e., ride slowest.

Ten points are awarded for the "winner" (slowest rider) with a deduction of one point for each time a foot touches the ground. Give the second place person six points, with the same one-point deduction for each time he or she touches the ground.

This develops balance and bike handling ability.

5. **Figure Eight:** Lay out a fairly tight figure eight path i.e., two thirty-foot circles that barely touch each other. Add additional markings so that the path this figure eight creates is two feet wide.

Have each kid ride the figure eight three times as slow or fast as they want. Deduct 1 point each time a kid's wheel touches a side.

6. **Stop on a Dime:** Create a single straight line, about twenty five feet long. One end is the start, the other end is the finish line, which you should mark clearly with a bold line, along with additional shorter markings every four inches a total of two feet in front of and behind it.

Have the kids begin at the start line, and ride toward the finish, aiming to stop pedaling and apply their brakes so that their front wheel ends up squarely on the main finish line. Deduct one point for each four inch marking that the rider stops in front of or behind the target finish line.

7. **Long Roll:** Find a spot that is either flat or goes slightly uphill. Create a start line and a mid-line about 25 feet past that.

Direct your kids to start pedaling at the first line and pedal like mad until they reach the next point, where they must begin coasting. The object of this event is to roll as far as they can, scoring more points the farther they go before touching the ground.

Give each kid a minimum of five points, and then add an additional point for each distance mark they hit beyond a certain point. You will probably need to have kids do a couple of test runs to get a sense of how far your kids can roll before you draw your lines showing scoring for distance achieved.

8. **Spiral:** Draw two-foot wide path that goes in a spiral around a large (five-foot diameter) circle. Have each kid ride the spiral from outside in as slow or fast as they want. Deduct 1 point each time a kid's wheel touches a side.
9. **Paper Boy:** This is a fun event that allows kids to play at being a newspaper delivery boy. You should include it if at all possible in your bike rodeo as it is always a real hit.

For this you'll need is five to ten targets (clothes baskets, large tubs, trash cans, etc.) and an equal number of rolled newspapers, plus a bag that can be slung over a shoulder to hold the papers.

Lay the targets out one after another in a course, and have the kids ride the "route" trying to throw a newspaper from the bike in each target. You can award points based on successful deliveries, i.e., putting the newspaper on target. Naturally, you should feel free to modify the rules, awarding more points for difficult targets, etc., whatever you need to do to make it fit your particular situation.

10. **Balance Beam:** Draw one main line about 30 to 50 feet long, with two smaller lines approximately three inches on either side of it. This will give you a path six inches wide that your riders should follow.

Have each kid ride the course, following the center line from one end to the other as slow or fast as they want. Deduct 1 point each time a kid's wheel touches a side.

The key to this is to be flexible, knowing that every one of these events can be modified to fit your setting and the age and ability of your kids. Regardless of how you finally end up structuring it, you can be sure that your kids will have a great time and learn lots about bike riding, honing their abilities in the process.

Compassion Ideas

Roundtable Prayer

Scouter Jim, Bountiful UT

Oh beloved Father, we thank thee for the blessing thou has given us, of life and the ability to help our fellowmen. We thank thee for the things thou have given us that grow to feed us and help heal in our afflictions. Please give us thy hand to reach out and help others; to plant and care for seeds of compassion, as we travel through our lives

Amen.

Barnyard Blues (& Golds) Planting Seeds!

Pamela, North Florida Council

Time to get out the straw hat, overalls (with Scout shirt under of course) and, hoe to sow seeds of kindness and Compassion. This would be a great month to set up your pack meeting like a barn or farm or have your meeting in a barn or at a farm! Usually barns are filled with hay or straw and bales of it would be a lot of fun. You can have the bales set up outside and have a marshmallow roast or baked apples at your meeting. You can even have a mock fire inside and tell stories. If your pack meeting is at a farm you may want to change the day so that Scouts can view the farm during the day, check out the animals and then attend the meeting. Hot Cocoa in the colder regions is always a welcome site so remember if you are going on an outing for your Pack meeting to include plans for a snack or food, first aid kit and your Cubmaster book with all the medical forms on everyone. *(even your adult leaders... they can fall ill or hurt on occasion as well.)* These early meetings should have your den leaders look at what kind of

advancement they can do as well at a farm. Remember: everything should have a purpose. If you only want to do advancement that's great but if you do arrive early, prepare a food as much as possible have Scouts hands on doing things so they do learn something new. Don't forget to ask a real farmer to come speak about his profession. He may even bring an animal or some of the things he grows and tell about them.

Compassion? Lots of ways to integrate farming or other subjects to help Scouts empathize with others or.. learn what its like to be in that persons shoes. Relay races or stations around the pack meeting about a given subject are always great. Ideas for a farm? Have a corn shucking relay, milk the cow relay, toting water relay, toting fire wood relay, cleaning the stall relay, moving feed bags relay. Washing potatoes relay, there are lots of things you can relay about that involve farms. But... always discuss what they learned. Which was the hardest, easiest, how could they make it easier, how often a farmer may have to do this, how much time they think a farmer may have to do this before it gets to their dinner table? All things to think about and help empathize and sow seeds of kindness and develop compassion for others.



Is THIS a PICTURE of COMPASSION?

Gathering Game in honor of National Buzzard Day

Enlarge and display this picture and challenge your audience to answer the following questions:

- ✎ Buzzards can't make that scary sound we hear in cartoons - they can only hiss or grunt, since they don't have voice box! **TRUE**
- ✎ Buzzards mate for life and take good care of their young. **TRUE**
- ✎ They can smell carrion from over a mile away. They also have good eyesight! **TRUE**
- ✎ During the hot summer months turkey vultures will "poop" on their feet to cool them off. **TRUE**
- ✎ Turkey vultures can travel up to 200 miles a day, and they don't eat while they are traveling **FALSE**
- ✎ Turkey vultures have been reported by aircraft pilots to rise to as high as 20,000 feet and soar for hours without flapping their wings. **TRUE**
- ✎ As groups of vultures catch thermal updrafts they look like water boiling in a pot – so they are called kettles. **TRUE**
- ✎ Hawks look for "kettles" – groups of flying vultures – because they know the vultures always find the best thermals! **TRUE**

- ✘ Buzzards are actually gentle birds – they can't kill their prey. And if they disappeared, we'd be overrun with dead animals! **TRUE**

EXTRA CREDIT

- ✘ Buzzards don't flap their wings, but just rock from side to side and ride the currents! **TRUE**
 - ✘ They are the most graceful fliers in the world, even though they look ugly and awkward up close! **TRUE**
- Note: Check the Fun Facts About Buzzards for more trivia – in VALUE RELATED*

No Matter How Small Story

Read "Horton Hears the Who" to celebrate the birthday of Dr. Seuss and "Read Across America Day," both of which are on March 2nd. A fun story about compassion – that teaches "A person's a person, no matter how small."

Johnny Appleseed Hidden Picture Challenge

From  NIEHS Kid's Pages:
Alice, Golden Empire Council

Johnny Appleseed, who was really named John Chapman, walked all over the country, planting apple seeds as he went, so that there would be trees for birds to nest in, people and animals would have fruit to eat and shade to enjoy on a hot day. He looked to future generations as he shared generously with people who would never know he had been responsible. He realized that both people and animals would benefit from the apple trees he planted – a great example of Compassion! See how many of the hidden items you can find.

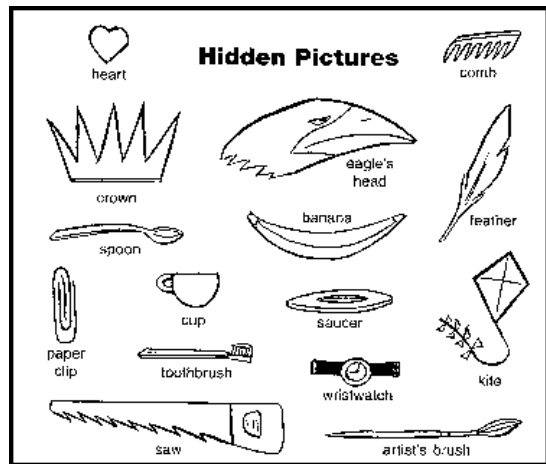

A Matter of Compassion Opening

Alice, Golden Empire Council

Before the meeting, prepare large letters that spell out COMPASSION, so that each boy in turn can hold up or post his letter on the wall. Boys could draw an appropriate picture on the side with their letter. have what the boys will say on the back of the cards in large letters.

- Emcee:** This month, we've been learning all about a Core Value.
- Cub # 1:** (Posts letter C or holds it up) Caring for others is what Cub Scouts do – a Good Deed every day!
- Cub # 2:** (Posts letter O or holds it up) Only when you "Walk a Mile" in someone else's shoes can you really understand.
- Cub # 3:** (Posts letter M or holds it up) Make sure you treat others as you would like to be treated!
- Cub # 4:** (Posts letter P or holds it up) Put yourself in the other guy's place – it will change how you act.
- Cub # 5:** (Posts letter A or holds it up) Always use kind words and tone of voice.
- Cub # 6:** (Posts letter S or holds it up) Some people have special challenges that make it hard to walk or move.
- Cub # 7:** (Posts letter S or holds it up) Some people have special challenges that make it hard to read or talk like everyone else.
- Cub # 8:** (Posts letter I or holds it up) I learned how they feel with some of the games we played this month.
- Cub # 9:** (Posts letter O or holds it up) Overcoming challenges takes a lot of courage.
- Cub # 10:** (Posts letter N or holds it up) So NEVER forget to Do Your Best, no matter how you show Compassion to others!
- Emcee:** Let's now celebrate this great country, with the tradition of accepting people of all races and creeds, and the freedom to accept and help anyone with challenges!

(Go to Opening Flag Ceremony)

A Kind, Compassionate Hero Audience Participation

Utah National Parks

Parts:

ERIC	I'm a Cub Scout!
CHICK	Peep, peep
MICHAEL	Thanks, friend.

ERIC is a real hero. One day, he and **MICHAEL** were goofing off down by a pond that was in a remote area by where they lived. No one else was around.

MICHAEL was wading along the shore when he suddenly disappeared under the water. **MICHAEL** came to the surface sputtering and splashing wildly. **ERIC** did not know how to swim that well, but he seized a long branch and pushed it into the water toward **MICHAEL**. It didn't quite reach, so he waded in cautiously and pushed it further. Finally **MICHAEL** could get hold of it and was pulled to shore safely.

MICHAEL and his father were so grateful, they tried to give **ERIC** some money, but he wouldn't take it. He said he was a Cub Scout and wanted to help others.

ERIC is a hero in other ways, too. One rainy, cold day he was on his way to school. In the weeds he spotted a **CHICK**. It was cold and glassy eyed. He picked it up and cuddled it in his warm hands. He thought he would take it to school and show it to everyone, but instead he looked under a bush and saw a mother hen on a nest. He set the **CHICK** down close to her and it burrowed under her wing. She clucked at **ERIC** and pecked his hand. He knew the **CHICK** would be safe.

In **ERIC'S** school class there was a bully named Johnny. He especially loved to pick on Robert. Robert was timid and quiet and was never chosen to play games. One day **ERIC** got to choose the teams at recess. He chose Robert first. All the guys looked surprised, and Johnny jeered. That afternoon, when they were walking home from school, Johnny grabbed Robert and forced him to the ground. **ERIC** pulled Johnny off and stood between them until Robert could get up. Johnny threatened to hit them, but with two boys to fight, it wasn't so easy. Finally, Johnny left and the two boys walked home together.

ERIC always helps fold up the chairs and pick things up at the end of Den and Pack meetings.

All of us can be KIND HEROES. We may not save a life, but we can show compassion and be helpful to others.

Compassion Through the Ages Advancement Ceremony

Alice, Golden Empire Council

Before the Ceremony, each award is covered by a quote about Compassion. When the boy is called up, he reads the quote before receiving his award. See Quotes under Thoughtful Items near the front.

Cubmaster: There's a lot to think about if you want to practice being compassionate toward other people. Tonight, each boy is going to read a quote that will give us all some help in being more compassionate.

Call up boys and parents as usual, and ask each boy to read his quote before he is given the parent pin to put on his parent or guardian.

Be sure to lead a cheer for each Scout or group.

When all awards have been given....

Cubmaster: As you can see, Compassion can be shown in many ways – thank you Cub Scouts, for sharing some wise ideas about Compassion. And thank you for working hard to earn those awards!

Lead one final cheer for all!!!!

Passion for Compassion Song

Alice, Golden Empire Council

Tune - If You're Happy & You Know It

*Slow down the music on this one –
there are lots of big words to fit in –
but the thoughts are important to hear – Alice*

If you're happy and you know it, You must see –
That you have to think of you but also ME,

With a passion for Compassion,
You will always do what Right
When you always think of You but Also ME!

When you try to walk in someone else's shoes
It will help you know the action you should choose –
You will seek to be more kindly,
You will make a judgment blindly,
When you try to walk in someone else's shoes.

When you alter your perspective you will change,
And your feelings will expand to help arrange –
How you act and what you're saying
Will be kinder, and "fair-playing"
When you alter your perspective you will change!

Have a passion for Compassion, do what's right,
And your happiness will grow quite out of sight,
You'll bring happiness to others –
And you'll treat all men like brothers,
Have a passion for Compassion, Do what's Right!

To make Cub Scouts aware of the needs of others, here are some special games. These "disability awareness games" are fun in themselves, but they also serve to show able-bodied boys the problems of boys who have physical disabilities – and awareness is the first step in being compassionate!

Compassion Has No Limits Game

Alice, Golden Empire Council

Gather props, or enlarge the images shown below.

Narrator: Compassion – that was our focus this past month.
So let's review:



Cub #1: *(holding up clock or enlarged image)* Compassion is the right choice no matter what time of day or night it is.



Cub #2: *(holding up calendar or enlarged image)* And it doesn't matter what month it is – always practice Compassion!



Cub #3: *(holding up globe, map or enlarged image)* It also doesn't matter where you are – compassion can be practiced across the world!



Cub #4: *(holding up Elephant or enlarged image)* Dr. Seuss' story about Horton Hears a Who shows that it doesn't matter what size you are - You can be compassionate!



Cub #5: *(holding up a picture of Scouts of all ranks or enlarged image)* No matter what rank you are in Scouts, always remember that a Scout is kind and shows Compassion!

(As an alternate idea, you could have real boys come forward from the different ranks of Scouting – and they could then move right into the Closing Flag Ceremony- Alice)

Narrator: So when you leave here tonight, please remember:

All: Compassion Has NO Limits!

If It's Harder, It's Even More Important Cubmaster's Minute

Alice, Golden Empire Council

Most of us find it pretty easy to understand and relate to someone who is a lot like ourselves – and it's pretty easy to be kind and not be critical. But the true test of being a "Good Scout" is when we can look at someone who is different, who

worships a different God, who honors a different flag, who dresses in a different way, and we can put ourselves in that person's place, walk a mile in his shoes, and treat him as we would treat our friends. It's when we see someone who walks or talks or writes in a way that makes us uncomfortable – and instead of pity we feel a kinship – Now THAT'S compassion!

The Act of Compassion Cubmaster's Minute

Pamela, North Florida Council

The act of compassion begins with full attention, just as rapport does. You have to really see the person. If you see the person, then naturally, empathy arises. If you tune into the other person, you feel with them. If empathy arises, and if that person is in dire need, then empathic concern can come. You want to help them, and then that begins a compassionate act. So I'd say that compassion begins with attention. - Daniel Goldman

Connect with your World Cubmaster's Minute

Pamela, North Florida Council

Self-absorption in all its forms kills empathy, let alone compassion. When we focus on ourselves, our world contracts as our problems and preoccupations loom large. But when we focus on others, our world expands. Our own problems drift to the periphery of the mind and so seem smaller, and we increase our capacity for connection -- or compassionate action. - Daniel Goldman

Compassion and Friends Cubmaster's Minute

Pamela, North Florida Council

What does compassion mean? It means when we stop thinking about others and the way things are in others lives or fail to understand, we all become people who just ask, "What is in it for me?" That's pretty small word... of just one.. "me". Yes? Friends come in all shapes and sizes. Some tall, some short, some with not so good eye sight, some who take longer to understand things, some with special chairs that help them around but they are still all people just like you and me. They have feelings, want friends. It is said that in a life time you are pretty lucky to have one really, really good friend. Ask around. They will tell you that the majority of people will tell you they have or had one really good friend. Maybe two if they were fortunate. I'm talking about a friend who is there for you in any circumstance, give anything to help you (even his last dime), or doesn't run when you are in trouble. That's pretty awesome if you have a friend like that. Why would you avoid anyone just because they might be a little different when in actuality that might be the one really, really good friend? Don't miss out in discovering or finding a really good friend just because others may see them as different. See other people as an opportunity to finally finding one really good friend... or maybe even more!

Connecting COMPASSION with Outdoor Activities

Wendy, Chief Seattle Council

(Adapted from B.A.L.O.O. Appendix E)

- ★ **Hikes** - Take turns carrying items for each other on a hike. Do an "Inch Hike" to become aware of small animals we may harm if walking quickly.
- ★ **Nature Activities** - Make bird feeders and keep them filled for at least one winter season. Play "The Camera Game" from the *Cub Scout Leader's How to Book*.
- ★ **Service Projects** - Give service to elderly or disabled people, such as helping with trash, filling birdfeeders, planting flowers, sweeping, watering, taking in newspapers, etc.
- ★ **Games & Sports** - Experience a disability in a game or sport. For instance by being blindfolded or having an arm rendered unusable, teach understanding when others have trouble with a game. Never tease. Show how winning is doing one's best.
- ★ **Ceremonies** - Hold a ceremony to recognize compassionate behavior - especially compassion to peers.
- ★ **Campfires** - Give a skit showing compassionate behavior. Don't laugh if someone makes a mistake. Clap and cheer for everyone.
- ★ **Den Trips** - Visit shut-ins and/or elderly people at times other than holidays. Be patient and compassionate when waiting for others who need to rest or are slower.
- ★ **Pack Overnighter** - Bring someone who needs friends. Share belongings with others who may have forgotten something. Be kind to those who may feel uncomfortable being away overnight.

Lighthouse Game

An activity to increase awareness of visual impairments.

The leader is the lighthouse. Half the group will be the ships. They go to one end of the room and put on blindfolds. The other half are rocks and distribute themselves on the floor between the ships and the lighthouse, keeping their hands and feet in to minimize tripping.

The lighthouse says, "Woo, Woo" to guide the ships. The rocks go "Swish, Swish" quietly to warn the ships of their presence.

On "Go," the ships navigate between the rocks to the lighthouse. If they touch a rock, they are sunk and must sit on the floor (and go "swish, Swish" also). When all the ships have made it to the lighthouse (or have been sunk), the rocks and ships switch places.

After playing the game and making contributions to the World Friendship Fund, lead a den discussion:

- What does being *Compassionate* mean?
- What does it mean to have compassion for other people? Can you think of what compassion shows others about you?
- Can you think of a time when someone was kind or compassionate towards you? How did that make you feel? How would you have felt if the person or people were not kind or compassionate?

- What are two ways you can show compassion at school?
- How can you show compassion for someone who is having a difficult time? What can you do to show others that you have compassion? Can you think of a person who would benefit from compassion?

Craft panda magnets, magnets, neckerchief slides

CS Program Helps - 2003-2004, page 6 December and page 10 March

Makes panda magnets, magnets, neckerchief slides. Or pencil toppers. Use white and black pom poms and wiggle eyes. Attach a piece of magnet to the back or a piece of ½ " PVC pipe to make it into a neckerchief slide.

Character Connection: Compassion

The World Conservation pandas represent animals that are endangered in our world. We have an obligation to our future to protect all creatures.

- What do you think will happen to the animals of our world if their environment is destroyed? What does it mean to have compassion?
- Do you feel like you have compassion for animals? How would you feel if someone didn't care about you?
- What might make people feel compassion for animals? What can we do to show compassion for animals?

Late Breaking News Game

CS Program Helps - 2004-2005, page 10 January

Have the boys sit in a circle.

The object of the game is for each boy to add three words to a single story as it is passed around the group. The three words should help describe an incredible news story, the funnier the better.

The leader should begin the story slowly by saying something like, "Late last night,"

The second person might add, "...A green monster...";

And so on. If someone gets stuck and can't think of anything to add, keep going and go back to that person later.

Keep the game moving along.

Character Connection: Compassion

How do you decide what gets printed or reported? What choices did you make when you decided what to report?

- ✓ Why is it important to decide what to write about?
- ✓ Think about a time when someone said something dishonest about you. What was your reaction? How did it make you feel?
- ✓ How can you show that you have compassion for other's feelings?

One-Of-A-Kind Pet Craft

CS Program Helps - 2004-2005, page 6May

Materials:

- Craft odds and ends so that each Cub can create a pet that is one of a kind.
- For the body; a stuffed sock, block of wood, box, rock, empty tin can or even a berry basket.
- Additional materials may include construction paper, paper plates, plastic utensils, pipe cleaners, craft sticks, etc.

Directions:

- Cubs (and partners) may finish this project at home.
- Boys will bring their pets the following week so they can show their new pets to the rest of the den and tell their names, high light the kind of body they have, show how many legs they have, show the tail, etc.
- They can describe where the pets came from, what they eat, what they sound like, what they like to do, whether they live on land, in the water, or can fly, etc.

Character Connection: Compassion

- What do you think about the life of the animals at the shelter?
- When you give something to help, is it compassion? What does it mean to have compassion?
- Do you feel you have compassion for the animals at the shelter? How do you think the animals will react when they get these things?
- What else can you do to show compassion for these animals? Are there other animals we can feel compassion for (such as those in the rainforest, or endangered species)?

Nature Field Trip

Cub Scout Program Helps 2005- 2006 page 6 April

Lead a discussion related to the field trip:

- When we care about and try to help our fellow creatures, we call that compassion.
- Where do you see or feel compassion? For someone at school or in your family?
- How can you show that you have compassion for someone or something? What could you do to show others you have compassion for them?

Compassion -

2004 Pow Wow Book by Great Salt Lake Council

Having consideration and concern for the well-being of others. Don't isolate or exclude anyone. Everybody has something valuable to offer, and nobody likes being left out. Help your Cubs be aware of the needs of others. Disabled children deal with limitations imposed in their everyday lives.

Our Feathered Friends

2005 Pow Wow Book by Great Salt Lake Council

Use Dominos to demonstrate the chain reaction effect of showing compassion.

Line the Dominos up in a row as you mention compassionate deeds. Then knock the last Domino over to illustrate how showing compassion spreads. Add more compassionate deeds as necessary.

Example:

- 1) Build a birdhouse
- 2) Build a birdfeeder
- 3) Build a birdbath
- 4) Do not disturb a bird's nest

Compassion Reflection on Dominos:

- What do think will happen to the birds if their environment is destroyed?
- What does it mean to have compassion?
- Do feel like you have compassion for birds?
- How would you feel if someone didn't care about you?
- What can you do to show compassion for birds?

Butterfly Activity

Cub Scout Program Helps 2006-2007 page 6 May

Compassion - We've created three stages of a butterfly-- caterpillar, cocoon, and butterfly. (Tiger Elective 2)

- Has this helped you understand this animal and the challenges it faces in its life cycle?
- Do you want to be careful when you see a caterpillar? That is . How can you show compassion for other things?
- What can you do to practice compassion in the week ahead?

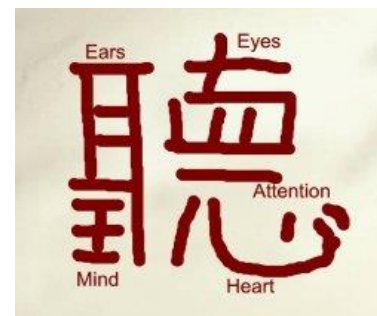

Kanji

http://www.peacelearningcenter.org/kanji_listening

The Japanese provide a simple approach to active listening. The symbol for active listening is made up of five smaller symbols, when placed together it is called KANJI.

Kanji listening means to listen to a speaker you must use all the senses. Specifically, you use your eyes, ears, heart and mind to give your undivided attention.

The Peace Learning Center has an interactive Kanji symbol that I found wonderful to use with scouts to foster discussion about compassionate interaction with individuals. Active learning is a skill that will help your scouts as they mature.

Flag Ceremony



March Flag Ceremony

You may want to incorporate the **CUB SCOUT NEIGHBORHOOD CODE** in a ceremony acknowledging the compassionate work done by your Webelos den.

Remember, one of the 10 **Purposes of Cub Scouting** is **Friendly Service**.

(Have three Webelos scouts offstage, ready holding the flags (the Color Guard). The US Flag is on the right, then State flag (if available), then Pack flag on the far left. Additionally, one Webelos scout acts as the **Leader** and two other flank the US and Pack flags as **Readers**.)

Leader: "Color Guard, advance!"

The audience and Scouts all rise.

Leader: "Color Guard, advance!"

(Wait for color guard to reach the front)

Leader: "Color Guard, Halt!"

Leader: "Color Guard, Cross the Colors!"

(US Flag crosses in front of others to left-most flag stand, and then states, then troop flags. wait for flag bearers to move to the flag pole stands)

Leader: "Color Guard, Post the Flag of Pack 123!"

Leader: "Color Guard, Post the Flag of the Great State of [your state name]!"

(US Flag remains held by bearer)

Leader: "Our flag stands for all that we hope to be and have the courage to try for. Let us join in a salute to the red, white and blue. Scout Salute (those not in uniform place their right hand over their heart). Please recite the Pledge of Allegiance!"

Leader: "TWO!"

(Everyone drops salute)

Reader 1: [Here your Webelos Scout provides a short description of a recent community project or good turn done by the den or pack.]

Leader: "Cub Scout Sign!"

(Everyone raises right hand making the Cub Scout sign)

Leader: "Please join us in reciting the Cub Scout Neighborhood Code"

Reader 2: Lead it by the repeat-after-me method. (Slant-marks indicate pauses.)

I will do my best/
To make my neighborhood/
A good place to live./

I will set a good example/
By keeping my sidewalks/
And grounds clean./
I will not litter./
I will not damage/
Private or public property./
I will be a good neighbor/
By trying to be/
Helpful and friendly to others./
I will respect other people./

Leader: "TWO!"

(Everyone drops Scout sign)

Leader: "Color Guard, Post the Flag of the United States of America!"

Leader: "Color Guard, Honor your Colors!"
(Flag bearers salute the US flag)

Leader: "Color Guard, return to ranks!"

(Wait for flag bearers return to formation and all people to sit)

Be Aware and Care Ideas

Planting Seed of Kindness Opening

Alice, Golden Empire Council

Background -

- A picture made by boys showing good soil, with rocky, dry soil along one side; several "seeds" drawn on paper
- Watering pail or picture of rain
- Picture of sun
- Pictures of "crops" – flowers, wheat, sunflowers, etc.
(Adjust number of seeds to the number of boys)

Narrator: This month, we've been learning about Seeds of Kindness. Let's see what can happen to those seeds. The seed is an idea – we might hear about a service project from our den leader or a teacher. If we decide to help, we might want to find out what we can do.

Cub Scout #1: I heard about a canned food drive from my den leader, and I wanted to help.

Cub Scout #2: My neighbor is old and has trouble keeping her lawn mowed and watered. I wondered if I could help.

Narrator: Sometimes, when we hear about some service or see someone who needs help, we decide to try and find a way to do something. It's like putting seeds in good soil, where they can grow. But sometimes, we are busy or the problem seems too big for us to do anything about, so we decide we can't help. That's like dropping a seed in rocky, dry soil, where it can't grow. It will just dry up and nothing will come of it.

Cub Scout #3: I heard about the canned food drive, but I don't have time to help – I have soccer practice, and a game on Saturday.

Cub Scout #4: I asked my dad, but he said the local food bank will take care of the problem.

Narrator: Where do you think these seeds ended up? *(Lets the audience decide where each boy should put his seed)* But just getting in the dirt doesn't guarantee a seed will grow – it needs water and sunlight. The water could be compared to a willingness to figure out a way to help, a way to deliver what someone else needs.

Cub Scout #5: I wanted to help with the food drive, too – I decided to ask my neighbors if they could help, so we would get even more cans!

Cub Scout #6: I saw that my neighbor couldn't take care of her lawn anymore, so I asked my dad if he could help me get the lawn mower started and figure out how to finish the job.

Narrator: *(holds up the watering can and adds the sun to the picture)* If we use our imagination and ask other people to help, our "seeds of kindness" can keep growing.

Cub Scout #7: When I went to pick up cans from my neighbors, one of them said they had a grandma who needed help from the food bank sometimes. They said they were happy to help, and that made me feel good!

Cub Scout #8: It was a lot of fun to find a way that I could help – I collected coats from my family, kids at school, and neighbors, and donated them to a clothing drive. I had such a good time that I am going to do it again! And it made me very glad that I have my own warm clothes for the winter.

Narrator: So we discovered that "Seeds of Kindness" grow only when we each decide to do something for others. Then they can produce a crop of gratitude, and a desire to do more. We have learned to keep our eyes open for other opportunities to be kind. *(Put up the picture or drawing of flowers or a food crop)* In the United States of America, we have a tradition of helping others. Let us honor that tradition by pledging allegiance to our flag.



Helping Others

Capital Area Council

Divide audience up into six parts.

Assign each part an action to do and say when their key word is read. Practice as you assign parts.

- Lights:** "Blink, blink, blink"
- Cub Scout:** "Do Your Best"
- Helping Other People:** "Warm Fuzzy"
- Pack:** Yell the Pack Number

Old Lady: "No, I Don't Want To Go"
Tree: "Ahhhhhhhhh"

Once upon a time, in a **CUB SCOUT PACK** a **CUB SCOUT** was learning about **HELPING OTHER PEOPLE**. The **CUB SCOUT** helped an **OLD LADY** across the street. But the **OLD LADY** did not want the **CUB SCOUT** to help her. The **OLD LADY** did not care that the **CUB SCOUT** had been learning about **HELPING OTHER PEOPLE** or that the **CUB SCOUT** and his **PACK** had set out to do good deeds. The **OLD LADY** just wanted to get a **TREE**. But the **CUB SCOUT** and his **PACK** were learning about **HELPING OTHER PEOPLE** and really wanted to **HELP OTHER PEOPLE** and so the **CUB SCOUT** helped the **OLD LADY** across the street. The **OLD LADY** thought what kind of a **PACK** is this?

The **OLD LADY** just wanted her **TREE** and pretty **LIGHTS**. The **CUB SCOUT** said, "Nice **OLD LADY**, my **CUB SCOUT PACK** and I are learning about **HELPING OTHER PEOPLE**. I'll help you get your **TREE** and put your pretty **LIGHTS** on, if you will just let me learn about **HELPING OTHER PEOPLE** by getting you across this busy street." The **OLD LADY** sighed and smiled and said "Thank you."

Mighty Oaks From Little Acorns

Baltimore Area Council

Materials needed: Paper cup filled with soil, quick sprouting seeds such as alfalfa, water

Set Up: When a boy is ready to advance from one rank to another, the Cubmaster calls him to the front of the Pack Meeting with his parents and says the following:

Cub Scout _____, you have within you the seed of a man. Through Scouting, that seed may grow. Your advancement tonight from _____ to _____ is part of that growth.

To help you better understand the growth you have to make, we give you this cup of soil (hand cup to Cub), which represents the fertile ground of Scouting with the opportunities and direction it affords you for growth.

When you became a Cub Scout, you planted your seeds in this soil. (Hand Cub seeds to plant in soil.)

For a seed to grow, it must have nourishment. Your Den Leaders nourish your seeds through the activities and projects you work on at den meetings each week. (Have Den Leaders water the soil.)

No seed can grow without the warmth of the sun. By their encouragement and support in Scouting, your parents provide the warmth needed for your own seed to grow. (Ask the parents to help their son place his cup in a sunny spot at home.)

Now, Cub Scout _____, as you receive your advancement, we instruct you to take these seeds home and care for them so they will grow into healthy strong plants. And we promise you that as your seeds grow through the care you give them you too will grow through the care your Cub and Scout leaders give you as you go through the Scouting program.

Garden Song

Baltimore Area Council

To hear the song -

<http://www.gardenofsong.com/midi/gardensong5.mid>

On You Tube -

Arlo Guthrie -

<https://www.youtube.com/watch?v=9QTj45cTB4U>

Peter, Paul & Mary

<https://www.youtube.com/watch?v=q4potvqf-v8>

Chorus:

Inch by inch, row by row
Gonna make this garden grow
Gonna mulch it deep and low
Gonna make it fertile ground
Inch by inch, row by row
Please bless these seeds I sow
Please keep them safe below
'Till the rain comes tumbling down

Pullin' weeds and pickin' stones
We are made of dreams and bones
Need a place to call my own
'Cause the time is close at hand
Grain for grain, sun and rain
Find my way in nature's chain
Till my body and my brain
Tell the music of the land

Chorus

Plant your rows straight and long
Season with a prayer and song
Mother Earth will make you strong
If you give her loving care
An old crow watchin' hungrily
From his perch in yonder tree
In my garden I'm as free
As that feathered thief up there

Chorus**Baden-Powell & Good Deeds**

Alice, Golden Empire Council

Setting:

- An adult dressed as Baden Powell, and standing off to the side of the stage (or a large picture of him, with the sound of his voice coming from off-stage.)
- A group of Cub Scouts are sitting in the middle, looking like they are talking. (moving their mouths and hands, but not saying anything) If possible, it would be great to have stars on the wall behind the boys, with small white Christmas lights, not turned on, but able to be turned on at the end.

Baden-Powell: When I founded scouting, I wanted boys to learn how to take care of themselves. But I also taught them to be kind to others – to do a good deed every day. I often think (that) when the sun goes down, the world is hidden by a big blanket from the light of heaven – but the stars are little holes pierced in that blanket by those who have done good deeds in this world. The stars are not the same size; some are big, some are little, and some men have done small deeds – but they have

made their hole in the blanket by doing good before they went to heaven.

- Cub #1:** (Looking at a second boy) Wow, you're doing great – you almost have the Promise memorized! But remember to put in “..to help other people” – Baden-Powell wanted scouts to always do a good deed each day.
- Cub #2:** What kind of good deed?
- Cub #1:** Well, Saturday my family helped plant trees along the river – it was hard work, but fun, too. And boy, did I get dirty!
- Cub #3:** Today, I helped my den leader clean up after we finished our project – that was a good deed, too.
- Cub #2:** So, I need to do a good deed every day? Sounds kind of hard.
- Cub #4:** Well, sometimes you have to work hard to do a good deed – me and my dad helped my neighbor paint his fence – and that was hard work.
- Cub #5:** But sometimes, a good deed is pretty easy. There's a new boy in my class, and he was kind of lost – so I helped him find the cafeteria and meet some of my friends – I guess that was my good deed for the day.
- Cub #2:** Hey, I helped my Mom bring in all the groceries from the car – was that a good deed.
- Cub #6:** Sure, that was a good deed. Just remember to be kind and helpful, and you won't have any trouble doing a good deed each day...
- (pauses, then looks like he has a great idea) Hey, even helping you learn the Cub Scout promise is a good deed!

Talking Clearly:

- ★ Give each participant a large marshmallow (they do not chew or swallow after putting it into the mouth) and have him or her try to talk clearly.
- ★ Have them say their name or the Cub Scout motto.
- ★ Discuss with the participants their feelings.
- ★ Point out for some people this is how they normally talk.
- ★ How much effort was needed to be clearly understood by each other?
- ★ Did you have to listen more carefully? Was this frustrating either to listen or try to talk?

Cub Scout Garden

Pamela, North Florida Council



Set Up: Have Cub Scouts make signs and carry them out as the vegetable are announced.

Personnel: 5 Cub Scouts, and Cubmaster (CM) (or other leader)

I like to do this by having the Cubs have a sign for each item and posting them on a flannel board or Bulletin Board as they call each item. (i.e. you would have sign for each of the 5 peas telling what it is, preparedness, promptness, ..)

Cub #1: First plant five rows of peas.

- ★ Preparedness
- ★ Promptness
- ★ Perseverance
- ★ Politeness
- ★ Praise

Cub #2: Next, plant five rows of lettuce:

- ★ Let us be Faithful
- ★ Let us be Unselfish
- ★ Let us be Loyal
- ★ Let us be Truthful
- ★ Let us help one another.

Cub #3: Next to them. Plant three rows of squash

- ★ Squash impatience
- ★ Squash criticism
- ★ Squash indifference

Cub #4: No garden is complete without turnips:

- ★ Turn up for pack meetings.
- ★ Turn up with a new idea.
- ★ Turn up with determination.

Cub #5: And one row of carrots

- ★ "Carrot" (Care at) all time

CM: Without the help of every person in our pack, our garden will turn to weeds. So help us build the background, work the soil, pull the weeds, and spread the sunshine so that in the garden of Pack we can say; "We have done our best"

Do More

Sam Houston Area Council

Prop: A candle lit by the leader

Cub Scout #1: This candle represents the spirit of Cub Scouting the world over. It burns today to show the friendship and fun we share.

Cub Scout #2: But there is more that we can do to spread seeds of kindness. Listen:

Cub Scout #3: Do more than belong. Participate

Cub Scout #4: Do more than care. Help.

Cub Scout #5: Do more than believe. Practice.

Cub Scout #6: Do more than be fair. Be kind.

Cub Scout #7: Do more than forgive. Forget.

Cub Scout #8: Do more than dream. Work.

Cub Scout #9: Do more than teach. Inspire.

Cub Scout #10: Do more than live. Grow.

Cub Scout #11: Do more than be friendly. Be a friend.

Cub Scout #12: Do more than give. Serve.

Holiday Pledge Of Allegiance

Chief Seattle Council

Set Up: A narrator to say the lines of the Pledge of Allegiance and 6 Cub Scouts to say the accompanying lines.

Someone to play music. While this ceremony is being done, background music (such as "Joy to the World".) plays softly.

Narrator: I pledge Allegiance

1st. Cub: At this joyous time of year

Narrator: To the flag

2nd Cub: A symbol of unity as Christ is a symbol of peace

Narrator: Of the United States of America

3rd Cub: A land chosen above all others

Narrator: And to the Republic for which it stands

4th Cub: The people who care and share

Narrator: One Nation under God

5th Cub: Who shared his son with us

Narrator: Indivisible

6th Cub: A nation united through love

Narrator: With Liberty and Justice for all

Then ask all in attendance to join with you and repeat the Pledge of Allegiance.